

EN /  
2021

PROFESSIONAL  
FIRE

FIRE DETECTION AND VOICE  
EVACUATION SYSTEMS

 **Comelit**<sup>®</sup>  
Passion. Technology. Design.



ITALY

FRANCE

SPAIN

IRELAND

BELGIUM

NETHERLANDS

GREAT BRITAIN

IRELAND

GREECE

UNITED ARAB EMIRATES

RUSSIA

HONG KONG

REPUBLIC OF SINGAPORE

AUSTRALIA

COLOMBIA

UNITED STATES OF AMERICA

# PROFESSIONAL FIRE

Guaranteeing the safety of people and property is the primary objective of fire detection systems. Comelit makes the most advanced and innovative technologies available to every installer, to ensure the aim of safety is met in every context. Our comprehensive range offers diverse solutions from small-scale applications to integrated systems, with the assurance of being able to utilise all our services during the various project development stages. **Comelit. With you always.**

- COMELIT IS AN INTERNATIONAL GROUP SPECIALISING IN PROFESSIONAL INTEGRATED FIRE AND SECURITY SYSTEMS.

DESIGN  
MILANO  
ITALIAN-DESIGNED  
PRODUCTS



ISO 14001  
CERTIFIED  
COMPANY

Comelit has been constantly striving to provide customer satisfaction since 1956. Innovation through continuous investment in manpower and technology finds an outlet in the design of new solutions featuring elegant Italian-made design and dedicated to improving the quality of everyday life by maximising simplicity and functionality.



## COMELIT, WITH YOU ALWAYS. NO-ONE ELSE OFFERS YOU SO MUCH.

Always being close to our customers means, for us at Comelit, listening to their requirements, identifying the solutions which best adapt to their specific needs, offering the assurance of constant assistance in every situation, always guaranteeing the quality of our products and systems, and offering a uniquely broad range of services. Because the success and the professional satisfaction of every installer who chooses our brand is our goal and the reason behind our everyday commitment.

# WITH YOU ALWAYS



Easy to install and program, state-of-the-art, reliable, extremely versatile and highly integrated products. Anyone who chooses Comelit solutions knows they can count on having a single representative, who can help them identify the products and systems most suited to their needs and assist them as necessary at all stages of their activity.

### **NATIONWIDE TECHNICAL ASSISTANCE FOR DESIGN ADVICE AND ON-SITE ASSISTANCE.**

Comelit installers can always count on the invaluable support offered by our technical assistance service, which includes quick responses to requests for information, on-site assistance and design advice.

### **COMELIT ENGINEERING**

For all non-standard system requirements, we have an operative division dedicated entirely to researching, designing and creating the ideal solutions for specific needs.



## CONTACTS.

- [ IT ] **Comelit Group Spa**  
Via Don Arrigoni 5  
24020 Rovetta S. Lorenzo  
Bergamo Italy  
Tel. +39 (0) 346 750011  
Fax +39 (0) 346 71436  
www.comelitgroup.com  
info@comelit.it
- [ AU ] **Comelit Australia Pty Ltd**  
Unit 6/11 Sabre Drive  
Port Melbourne  
Victoria 3207  
Ph. 1300 889000  
enquiries@comelitgroup.com.au
- [ BE ] **Comelit Group Belgium**  
Kleinewinkellan 24  
1853 Grimbergen  
Belgium  
Tel. +32 2 411 50 99  
Fax. +32 2 411 50 97  
www.comelit.be  
info@comelit.be
- [ DE ] **Comelit Group S.p.A. Deutschland**  
Konrad-Zuse-Str. 2  
41516 Grevenbroich  
Tel. 0 21 82-82 96-0  
Fax: 0 21 82-82 96-299  
www.comelit.de  
info@comelit.de
- [ ES ] **Comelit Group Spa Sucursal en Espana**  
Calle Pintor Roig i Soler, 28  
08916 - Badalona (Barcelona)  
Tel. +34 932 430 376  
Fax +34 934 084 683  
www.comelit.es  
info@comelit.es
- [ FR ] **Comelit Immotec**  
18, rue Séjourné  
94000 CRETEIL CEDEX  
Tél. +33 (0) 1 43 53 97 97  
Fax +33 (0) 1 43 53 97 87  
www.comelit.fr  
contact@comelit-immotec.fr
- [ GR ] **Comelit Hellas - Telergo Security Ltd**  
Roumelis, 59  
16451 Argiroupoli - Athens  
Greece  
Tel. +30 210 99 68 605-6  
Fax +30 210 99 45 560  
www.comelit.gr  
telergo@otenet.gr
- [ IE ] **Comelit Ireland**  
Ground Floor  
14 Herbert Street - Dublin 2  
Tel. +353 (0) 1 619 0204  
Fax +353 (0) 1 619 0298  
www.comelit.ie  
info@comelit.ie
- [ NL ] **Comelit Nederland BV**  
Buitendijks 1-3356 LX  
Papendrecht  
Tel. +31 786511201  
Fax +31 786170955  
www.comelit.nl  
info@comelit.nl
- [ SG ] **Comelit South East Asia Pte Ltd**  
Victory Centre  
110 Lorong 23 Geylang, #05-10  
388410 Singapore  
Tel. +6567024780  
www.comelit.sg  
office@comelit.sg
- [ AE ] **Comelit Middle East**  
Office EG-08 DSO HQ Dubai,  
UAE  
Tel: +97 143 331 114  
www.comelit.ae  
info@comelit.ae
- [ GB ] **Comelit Group UK Ltd**  
Unit 2B, The Quad,  
Butterfield Business Park,  
Luton, Bedfordshire. LU2 8DL  
Tel: +44 (0)1707377203  
Fax: +44 (0)1707377204  
www.comelitgroup.co.uk  
sales@comelitgroup.co.uk
- [ US ] **Comelit Usa**  
2021 S. Myrtle Avenue  
Monrovia, CA 91016  
Tel. +1 626 930 0388  
Fax +1 626 930 0488  
www.comelitusa.com  
sales@comelitusa.com
- [ RU ] **Comelit Group Russia**  
Moscow,  
Krasnogvardeisliy bulvar, 7A  
tel: +7(495)789-49-33  
www.comelit.ru  
mail: tsn@comelit.ru  
mail: info@comelit.ru
- [ HK ] **Comelit Hong Kong**  
Representative Office  
Rm 601, 6/F,  
Tung Hip Commercial Building,  
248 Dex Voeux Road Central,  
Office direct line:  
+852 3582 1632  
www.comelit.hk  
info@comelit.hk

pro.comelitgroup.com www.comelitgroup.com

Follow us:





# CLOUD FIRE

Cloud services are also an extremely important evolution in the fire detection sector.

THE APP AND THE MYCOMELIT PROFESSIONAL PORTAL OFFER CUSTOMERS THE OPTION OF CONSTANTLY AND INSTANTLY CONTROLLING AND MONITORING THE OPERATING STATUS OF COMELIT SYSTEMS.

The new connected Logifire control panels allow constant monitoring of alarms and faults for all system components, whether they are part of the main detection systems or the evacuation and extinguishing subsets. The push notification instant messaging service allows the user to take instant corrective action in order to guarantee the utmost security, keeping people and property safe.

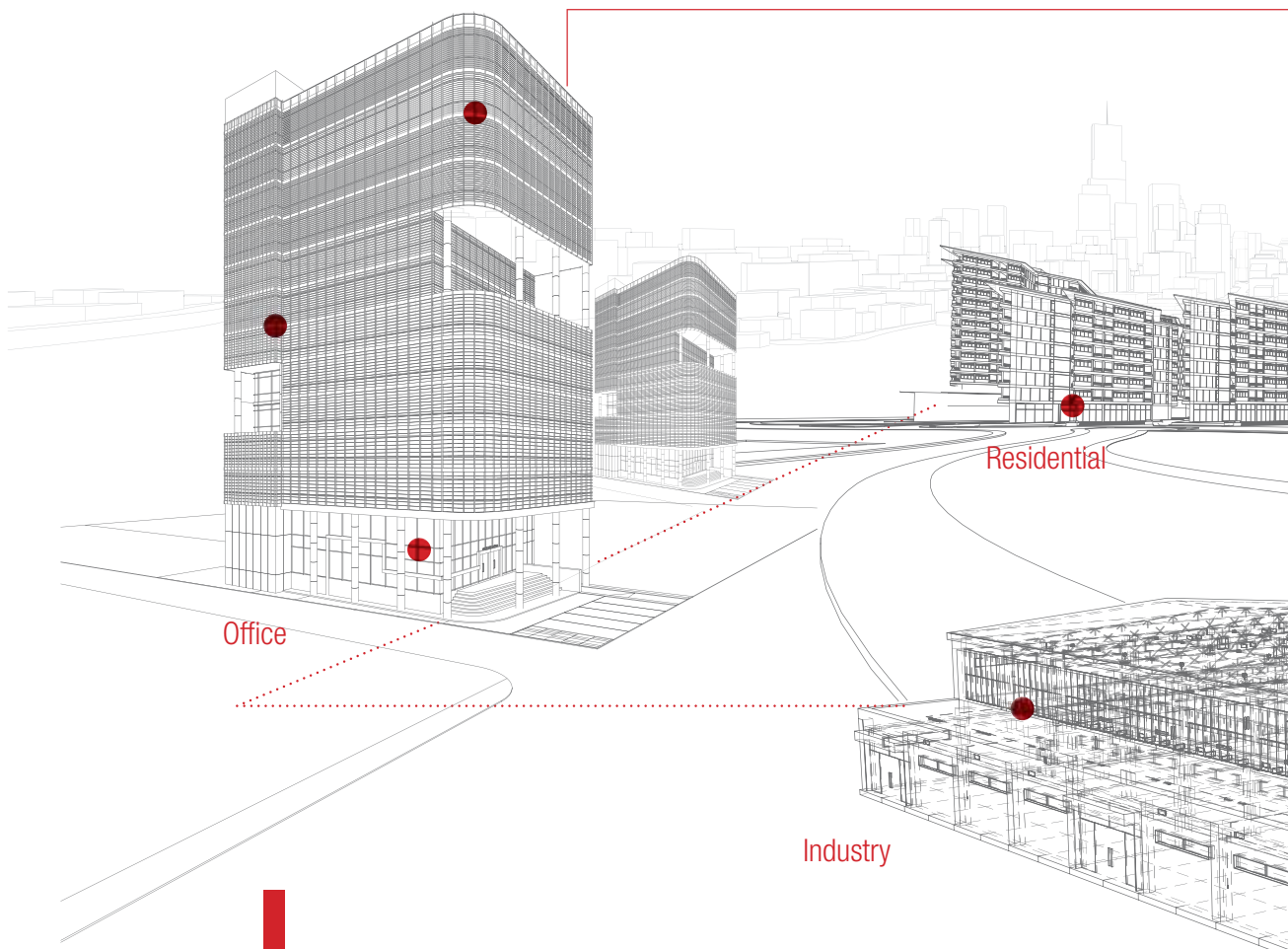



The MyComelit Fire platform, which can also be utilised via App, allows:

- » analysis of the “**vital parameters**” of the system, such as faults, alarms, event log and recent notifications.
- » “**real-time**” **diagnosis** which can be used to identify the specific problems of each individual component.
- » **status analysis** for individual Loops, Zones, individual devices and peripherals.
- » the execution, via code and level, of **commands** such as silencing, reset, disablement of individual components.
- » **maintenance management** (governed by regulations) which makes it possible to plan work, check deadlines and consult all the documentation produced in the test phase for individual systems.

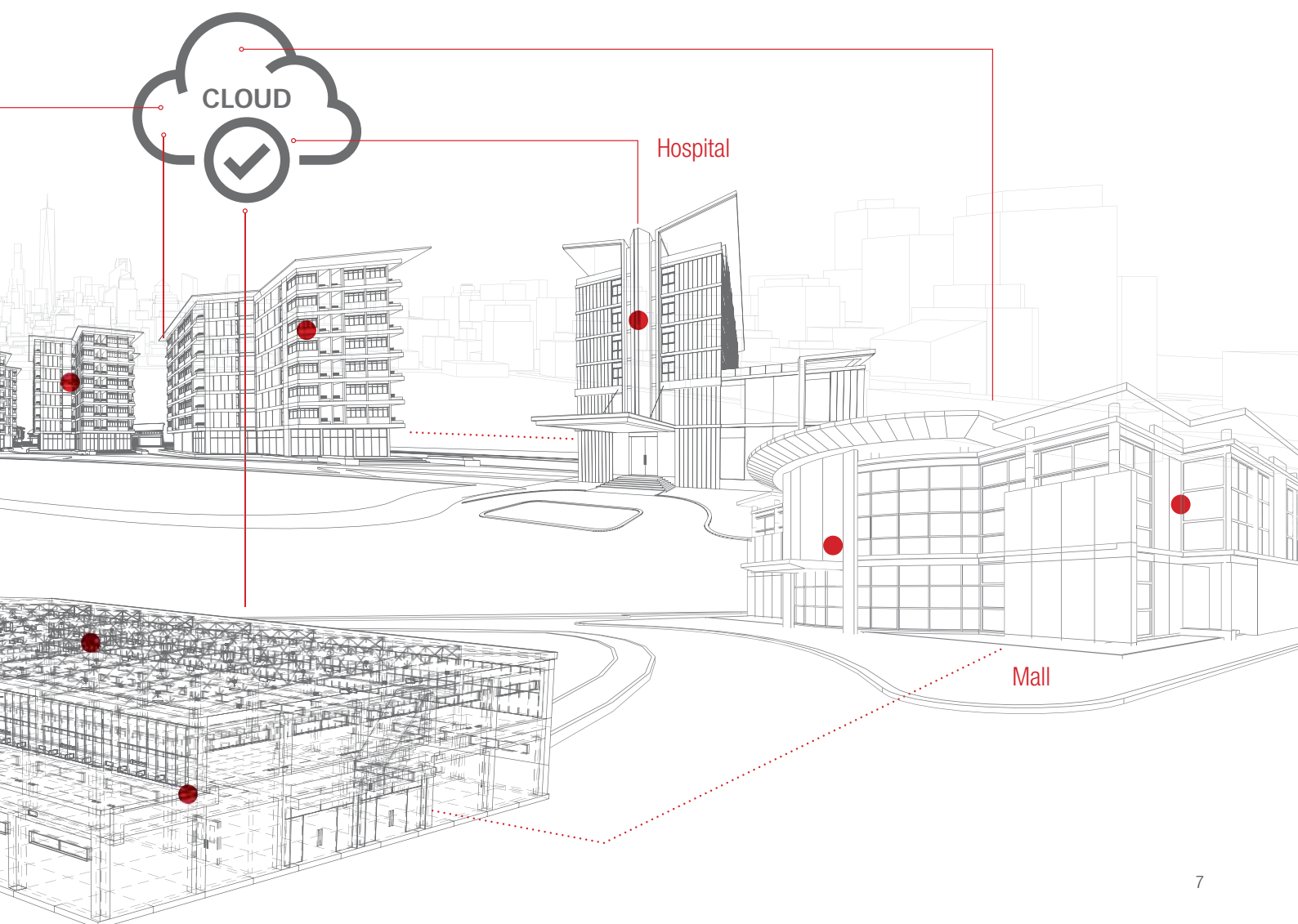

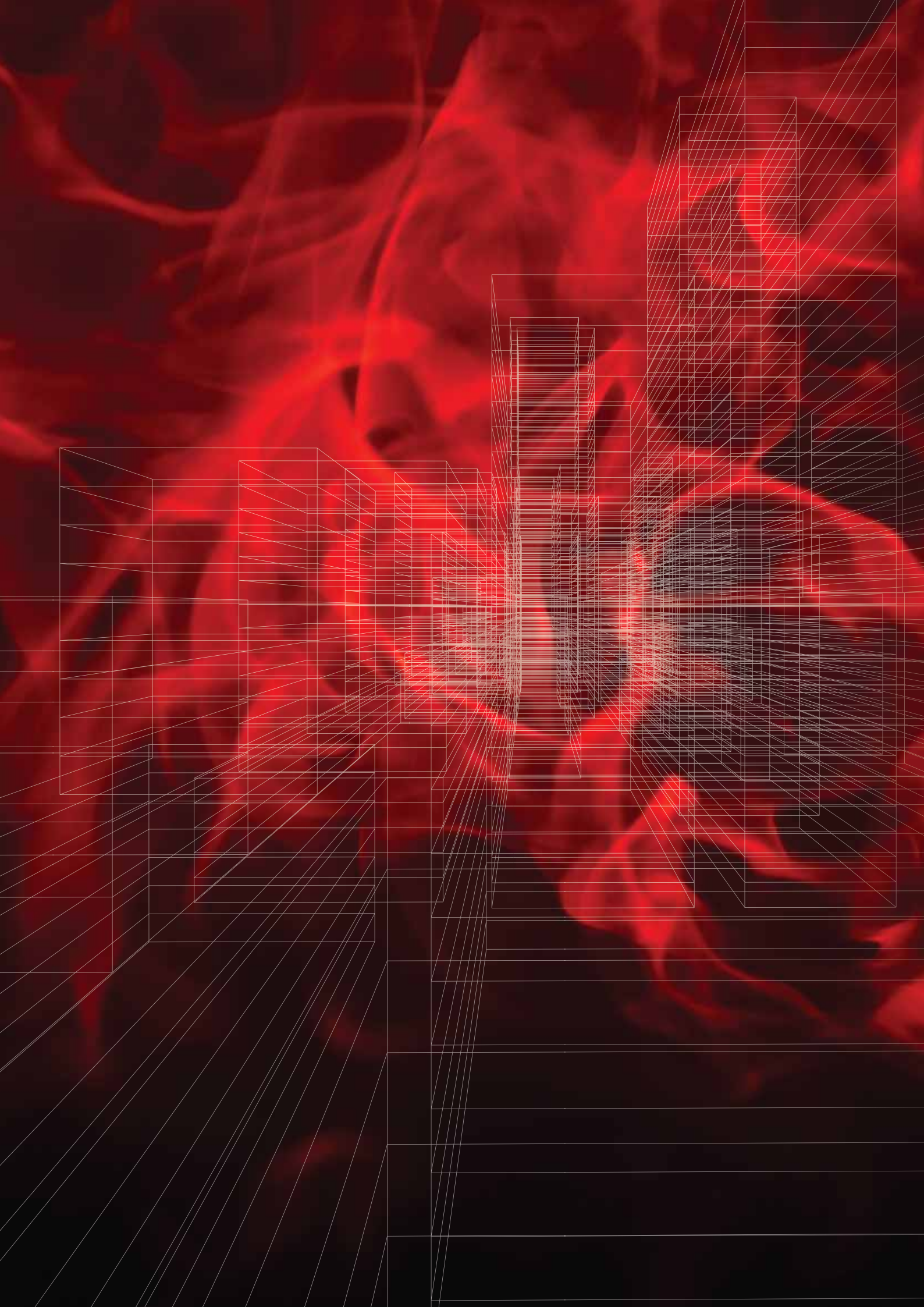





## FIRE PROTECTION SOLUTIONS

ADDRESSABLE	10
CONVENTIONAL	20
WIRELESS	28
EXTINGUISHING	32
SIGNALLING	36
ASPIRATION	42
BEAM DETECTION	50
GAS DETECTION	54
ATEX	62
COMMON ACCESSORIES	66
EVAC	72
SYSTEM DIAGRAMS	80
REGULATIONS	86
SOFTWARE AND CALCULATION TOOLS	94
TECHNICAL TABLES	100



# THE ADDRESSABLE RANGE

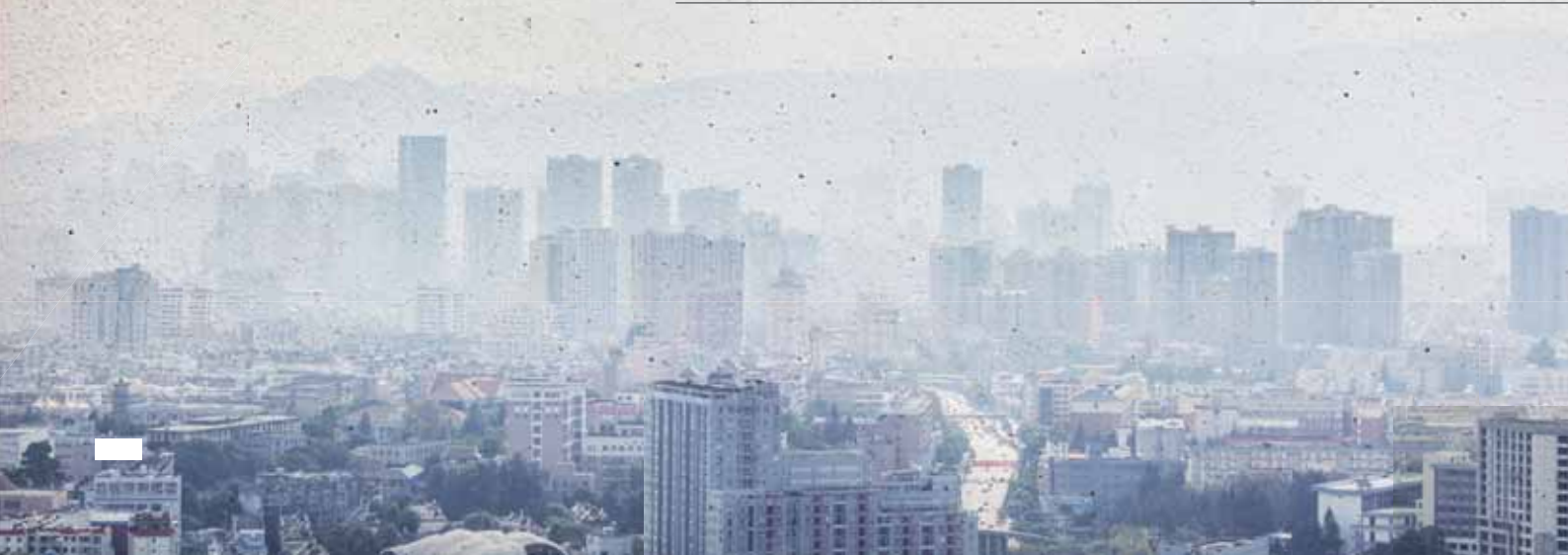

## ELEGANCE, SECURITY AND INNOVATION: IN A WORD, **LOGIFIRE**

LogiFire represents the complete technical and aesthetic evolution of the addressable range by Comelit, with reliability and performance levels that have allowed the Comelit brand to consolidate its position as a central player in the fire detection sector.

The future is guaranteed by the new range of control panels that can be expanded from 2 to 8 loops, by the new 7" Touch screen featuring a new revolutionary and intuitive user interface, by backwards compatibility with the old series, by the 200 zone LEDs, by the network of up to 64 control panels, by the TCP/IP interface provided, by the MODBUS protocol, by the integration with voice Evac systems and by the other functions to be explored.

The complete range of devices in the LogiFire range, along with their versatility and ability to adapt to any installation and programming requirements, make them the perfect choice for guaranteeing safety in all sites requiring protection.

The product design is the other unique feature of the new range; its carefully constructed lines and its neutral appearance in any environment in which it is installed make it perfect for installation in any setting. These features are combined with other technical innovations, analysis algorithms for false alarms, and simplified cleaning and maintenance procedures.

The LogiFire range by Comelit: your detection choice for the future.

### APPLICATIONS

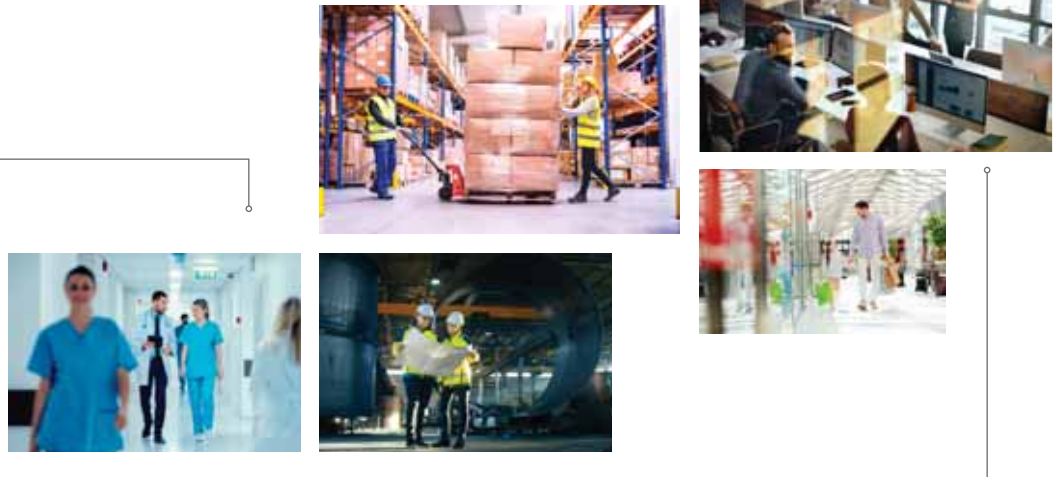

### ADVANTAGES

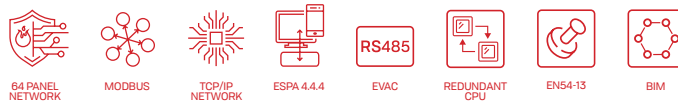



## ADDRESSABLE PANELS

The new range of addressable control panels offers various solutions linked to installation environment.

The 41CPE112 entry-level control panel, in its new metal case, is applied in small systems with a basic 1-loop provision that can be expanded to 2, for a total of 500 devices. Through the 41ECB000 interface, it can be integrated into the redundant network (64 Network). The 41CPE118 control panel is at the top of the LogiFire range.

Basic model in metal case with an innovative design, plenty of room for wiring, detachable door, 200 LEDs, 7" resistive Touch Display with new GUI, Redundant CPU, can be expanded in its case from 1 to 4 loops. The additional 41CPE104 box offers expansion up to 8 loops, for a total of 2000 devices. Micro USB for programming, TCP/IP interface provided, MODBUS, ESPA 444 protocol, FAT-FBF protocol, serial port for printer, RS485 interface for integration with EVAC compatible systems, redundant network of control panels (64 Panel Network) via 41ECB000 interface.

Option of mounting on 19" Rack or flush mounting using 41BIA100 accessory.

### 41CPE112

### 1 / 2 LOOP ADDRESSABLE FIRE PANEL LOGIFIRE EASY



LOGIFIRE EASY addressable fire panel is supplied as standard with 1 Loop, which can be expanded to 2 using board 41ECL022. Up to 250 addressed devices (detectors, MCPs, I/O modules, sounders etc.), divided into a maximum of 48 zones in total, can be connected to each loop. The control panel has a 5A power supply unit with 12 V output for battery. It has a strong metal container (430x330x150 mm) with the same dimensions as all the new Comelit LOGIFIRE series control panels, so as to guarantee optimum modularity and side-by-side pairing of the boxes during installation. All indications and commands are displayed on the front in compliance with the requirements set out by standard EN54-2, by means of LED indications and the alphanumeric LCD display with 4 rows of 40 characters. Fire alarm, Fault, CPU Fault, Delayed Alarm, Disablements, Test, Faulty/Disabled sounder, Confirm Fire Alarm, Faulty/Disabled Alarm Output, Extinguishing Started, Extinction Fault, Network Present, Alarm Silenced general indications. Direct commands for Silence buzzer, Silence siren, Reset, Evacuation, Signalling test. 4 menu navigation keys. **Approved to EN 54-2 and EN 54-4, conforms to EN54-13.**



EN54-2  
EN54-4  
EN54-13

2 LOOPS

LCD  
DISPLAY

BIM



# 41CPE118

## 1 / 8 LOOP ADDRESSABLE FIRE PANEL LOGIFIRE



The LOGIFIRE series 41CPE118 addressable fire panel is supplied as standard with 1 Loop and can be expanded to 4 using 3 x 41ECL120 boards, and up to a maximum of 8 Loops with the addition of metal cabinet (4 Loops, 1 as standard) Art. 41CPE104. Up to 250 addressed devices (detectors, MCPs, I/O modules, sounders etc.), divided into a maximum of 500 zones in total, can be connected to each loop. The control panel features a dual microprocessor and 14A power supply unit with 12 V output for battery, and has 200 LEDs on the front panel for zone status repetition. Fire alarm, Pre-alarm, Fault, CPU Fault, Delayed Alarm, Disablements, Test, Network Present general indications. Option of integration in monitoring systems with Modbus TCP/IP protocol and compatible with LOGIFIRE Redundancy Network through the use of art. 41ECB000. The control panel has a strong metal container (430x330x150 mm) with the same dimensions as all the Comelit LOGIFIRE series fire panels and boxes, so as to guarantee optimum modularity and pairing during installation. It displays all indications and commands on the front in compliance with the requirements set out by standard EN54-2, by means of LED light signals and the 7" resistive touch screen colour display. **Approved to EN 54-2, EN 54-4 and EN54-13.**



## ACCESSORIES



### 41CPE104

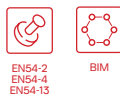

### 4 LOOP EXPANSION BOX FOR CONTROL PANEL 41CPE118

The expansion box 41CPE104 for LOGIFIRE series control panel 41CPE118 is supplied as standard with 1 Loop, which can be expanded to 4 using 3 x 41ECL120 boards. Up to 250 addressed devices (detectors, MCPs, I/O modules, sounders etc.) can be connected to each loop. When this is used, the 41CPE118 control panel can reach its maximum expansion, reaching a total of 8 Loops. It has a strong metal container (430x330x150 mm) with the same dimensions as the fire panel and all other Comelit LOGIFIRE series boxes, so as to guarantee optimum modularity and pairing during installation. Has a 14A power supply unit with 12 V output for battery (12 V / 18 Ah batt.). **EN54-2, EN54-4 and EN54-13 certified.**



### 41ALM172



### ADDITIONAL POWER SUPPLY UNIT FOR 41CPE118

LOGIFIRE series additional outdoor power supply unit, designed to supply addressed control panel 41CPE118 with additional power. Grey metal case with IP30 protection rating (430x330x150 mm), with the same dimensions as all Comelit LOGIFIRE series control panels and boxes to guarantee installation in modular structures. 5A power supply unit with 12 V output for battery, maximum battery capacity 2 x 12 V / 18 Ah. Continuous monitoring available by activating the "Monitor external power supply unit" option in the 41CPE118 fire panel menu. **Approved to EN54-4.**



### 41PRN100

### THERMAL PRINTER FOR CONTROL PANEL 41CPE118

LOGIFIRE series thermal printer for 41CPE118 addressed control panel. Can be used to print fire panel events in real time, with a maximum printing speed of 170 mm/second. Housed in a grey metal box with the same dimensions as all Comelit LOGIFIRE series control panels and boxes (LxHxD) 430x330x150 mm, so as to guarantee optimum modularity and pairing of the boxes during installation. There are 2 LEDs on the front door to indicate printer status. Connection to control panel 41CPE118 takes place via RS232 serial interface. Independent power supply (100-240 VAC). **EN54-13 certified.**

## ACCESSORIES



### 41CPR100



BIM



EN54-13



64 PANEL NETWORK



7" DISPLAY



### 41KPR101



### 41KPR102



### 41ECL120



### 41ECL022



### 41ECB000

RS485

EVAC



### 41ECN000



MODBUS



TCP/IP NETWORK

### REPEATER PANEL WITH TOUCH DISPLAY

The LOGIFIRE series 41CPR100 repeater panel can receive all the signals from the system and execute all the commands, even in a location far away from the control panel that cannot be easily accessed by operators. Has a 7" resistive touch screen colour display which replicates the user interface of the LOGIFIRE series 41CPE118 control panel. Maximum number of control panels/panels that can be connected in the RS485 network or TCP/IP LAN, 64. Direct commands for Silence buzzer, Silence sounder, Reset, Evacuation, Signalling test. Main power supply 24 Vdc. Maximum absorption 220 mA. Designed for desk base mounting using the optional kit art. 41KPR101 or flush mounting using the optional kit 41KPR102.

### DESK BASE KIT FOR 41CPR100

Option for desk base installation of LOGIFIRE series repeater panel 41CPR100. Option of mounting with 2 different tilts. Material: ABS. Colour: White RAL 9002.

### FLUSH-MOUNT INSTALLATION KIT FOR 41CPR100

Option for flush-mounted installation of LOGIFIRE series repeater panel 41CPR100. Material: ABS. Colour: White RAL 9002.

### 1-LOOP BOARD FOR ADDRESSABLE CONTROL PANEL 41CPE118

1-Loop expansion board for Comelit Logifire series addressable control panel Art. 41CPE118 and expansion box 41CPE104 (backwards compatible with ATENA control panel 41CPE024). Equipped with a removable terminal block; maximum number of devices that can be connected to each board: 250. Maximum current 700 mA. Cross-section of cables that can be used: 0.4 - 2.5 mm<sup>2</sup>. Operating temperature -10°C / +65°C. Relative operating humidity: (93 ± 3) % @ 40°C. Dimensions: 75x80 mm. Weight: 30 g.

### 1-LOOP CARD FOR ADDRESSABLE CONTROL PANELS 41CPE112

Maximum number of devices that can be connected: 250. Maximum current consumption: 500 mA. Cable cross section: 0.4 - 2.0 mm<sup>2</sup>. Operating temperature -10°C / +65 C. Operating relative humidity: (93 ± 3)% @ 40 °C. Dimensions: 75x80 mm. Weight: 30 g

### REDUNDANT BOARD FOR LOGIFIRE CONTROL PANELS

Redundant module expansion card for Atena and Atena Easy control panels. This can be used to create a redundant serial communication network between multiple ATENA, ATENA EASY control panels and repeater panels (up to a maximum of 64), thereby ensuring a backup line of connection in the event of a fault in the physical communication link. Maximum current consumption: 500 mA. Network type: redundant serial line. Maximum number of panels in network: 64. Maximum distance between two cards: 1000 m. Recommended connection cable: twisted pair 0.5 - 2.5 mm<sup>2</sup>, FP200.

### LAN EXPANSION CARD FOR 41CPE112

Art. 41ECN000 is a LAN communication module, designed for operation by means of serial communication with the LogiFire art. 41CPE112 and Atena Easy art. 41CPE012 fire alarm control panel (FW version 3.8.3 or higher). The module transmits incoming events to the LOGI MANAGER SUPERVISION SOFTWARE via LAN. This module is installed directly inside the case and is connected using the flat cable supplied with the module. LAN module art. 41ECN000 is programmed using the LOGI PROG programming software (version 5.3.9 or higher).



**41EVC100**



**FIRE / EVAC PANEL INTERFACE MODULE**

Module for interfacing addressable fire panels with Comelit voice evacuation panels (EVAC). Allows link connection of an addressable control panel (Atena / Atena Easy) with up to 5 EVAC panels (49CC0002/4/6). It also allows the fire panel to manage and activate the speaker lines, linking them to Fire Zone Groups for automatic alerting and evacuation of the rooms within the protected site. It alternates the messages transmitted by the EVAC control panels and activates the sirens in the fire panel Loop. The 41EVC100 interface is connected in place of the RS485 board (Art. 41ECB000) and link connection of the control panels takes place via the Ethernet cable. Communication between the 2 or more control panels takes place by means of the dedicated communication protocol.



**48BIA100**

**FLUSH-MOUNT BEZEL FOR LOGIFIRE CONTROL PANELS**

Metal frame for flush-mounted installation of Comelit LOGIFIRE series control panels and boxes.



**48CCB100**

**LOGIFIRE BOX FOR ADDITIONAL BATTERIES**

Metal container housing additional batteries for Comelit LOGIFIRE series fire panels. Can accommodate 2 x 12 V - 18 Ah batteries. Dimensions 430 x 330 x 150 mm.



**41CRA000**

**LOCK AND KEYS FOR COMELIT CONTROL PANELS**

Set of 5 spare locks with keys for the Atena/Atena Easy control panels



**41LTS000/  
41LTS000EN**

**LOOP TESTER**

Test instrument for initial analysis of Loop cables, finds and indicates the position of any short-circuits or open circuits within the Loop; after reading it feeds back the voltage values and resistance on the 2 branches of the circuit. Analyses the whole Loop by restoring values such as consumption in current, faults and, if they are already installed, it feeds back the total number of devices, listing them in address order; it finds and indicates and duplicate addresses or non-addressed devices. Encompasses functions of a fire protection control panel, such as the option of carrying out manual and automatic procedures (ID/IS), changing addresses and overriding the LED on board the devices. Multi-language menu. 4 navigation keys. Power supply unit included.



**41SPG000/  
41SPG000EN**

**HAND HELD PROGRAMMER FOR ADDRESSABLE DEVICES**

The programmer 41SPG000 is the instrument used to assign addresses to all the devices connected in the loop (detectors, modules, manual call points and audible/visual alarms). It can read and write the addresses and to set the parameters of the detectors and modules. It is supplied with a 230 Vac, 50 Hz/ 1.5-12 Vdc, 500 mA, 6 VA (max.) power supply unit and 2 cables for connection of the modules and manual call points. It can also be powered by 4 x 1.5 V AA batteries. The detectors and audible and visual alarm devices can be directly connected to the base on the upper part of the programmer. Dimensions: 255x102x65 mm. Weight: 260 g.



## ADDRESSABLE RANGE LOOP DEVICES



### 41RFU100



### 41RCS100



### 41RML100



### 41RBX020



### 48FPT100



### 43RBA002



### 41PAM000



#### ADDRESSABLE OPTICAL SMOKE DETECTOR

The LOGIFIRE series 41RFU100 detector is an optical Tyndall-effect smoke detector with a built-in isolator. The digital signal processing algorithms make it particularly sensitive to detecting smoke, even in the early stages of a fire breaking out. Microprocessor-controlled digital signal analysis. Contamination level auto-compensation and maintenance indication. Programmable sensitivity across three levels. Quick cleaning of the sensor chamber thanks to the intuitive disconnection of the components. Evolved design suitable for any type of installation, even in the most aesthetically demanding situations. High-visibility light indications. Automatic addressing or with programmer. **Approved to EN 54-7 and EN 54-17.**

#### ADDRESSABLE HEAT DETECTOR

The LOGIFIRE series 41RCS100 detector is a programmable multifunctional heat detector with a built-in isolator. It can detect temperatures over a fixed threshold or rapid changes in temperature ("rate of rise") as set out by standard EN 54-5. It can be programmed to operate in compliance with classes A1/R\*, A2/S\* and B/S. Microprocessor-controlled digital signal analysis. Quick cleaning of the sensor chamber thanks to the intuitive disconnection of the components. Evolved design suitable for any type of installation, even in the most aesthetically demanding situations. High-visibility light indications. Automatic addressing or with programmer. Programmable operating classes: A1/R, A2/S, B/S. **Approved to EN 54-5 and EN 54-17.** \*Certified classes.

#### ADDRESSABLE MULTI-CRITERIA SMOKE/HEAT DETECTOR

The LOGIFIRE series 41RML100 detector is a multi-criteria detector that combines the detection technologies of an A1R class rate-of-rise sensor with those of an optical Tyndall-effect smoke detector. The sensor is also fitted with a built-in isolator. Microprocessor-controlled digital signal analysis. Contamination level auto-compensation and maintenance indication. Programmable sensitivity across three levels. Operating class A1R. Quick cleaning of the sensor chamber thanks to the intuitive disconnection of the components. Evolved design suitable for any type of installation, even in the most aesthetically demanding situations. High-visibility light indications. Automatic addressing or with programmer. **Approved to EN 54-5, EN 54-7 and EN 54-17.**

#### STANDARD ADDRESSABLE BASE

The standard base for addressable detectors has a low-profile design and an extremely reliable sensor connection system that provides a secure fixing for the detector. Maximum cable cross-section: 3.0 mm<sup>2</sup>. Operating temperature -10 °C / +60 C. Operating relative humidity: (93 ± 3)% @ 40°C. Dimensions: 103x14.7 mm. Weight: 15 g.

#### REMOTE LED INDICATOR

The 48FPT100 remote LED repeater replicates the status of detectors in alarm mode. Compatible with the bases and detectors that support this function. Evolved design to guarantee an optimal solution for any type of installation, even in the most aesthetically demanding situations. Family feeling with the entire new range of LOGIFIRE sensors.

#### SPACER FOR ADDRESSABLE AND CONVENTIONAL DETECTORS

The spacer enables the input of pipes for visible systems and the mounting of conventional and addressable sensors, sirens Art. 41SCB100, 41SAB100, 41SCB000, 41SAB000/IS, 48SAI020, 48SCI040, 48SCI060 on uneven surfaces, suspended ceilings, etc.

#### ADDRESSABLE MANUAL CALL POINT

Addressable manual call point with built-in isolator. The button is equipped with a resettable special plastic key element (supplied) and sends an alarm signal to the control panel when it is activated by pressing the indicated point. It is equipped with an LED for signalling the alarm or test status. Wall mounting. Red ABS container. **Approved to EN 54-11 and EN 54-17.**





**41PAE020**



**ADDRESSED MANUAL CALL POINT IP67**

Manual call point with IP67 degree of protection, designed for use in addressed type detection systems. The manual recall point is equipped with a plastic reset key (supplied), when activated by pressing the indicated point, it sends an alarm signal to the control panel. It is equipped with a front LED to signal the alarm or test status. Flexible element restorable with special reset key. Wall mounting. Red container in ABS. Note: the declared IP67 degree of protection is obtained only if cable glands with IP67 degree of protection are used. **Conformity certification according to EN54-11 and 54-17.**



**43PAK000**

**SPARE KEY FOR FIRE BUTTONS**

Spare key for 41PAM000, 43PAM000, 41PAE020 and 43PAE020.



**43PAT000**

**PLASTIC COVER FOR MANUAL CALL POINT, SET OF 5**

Set consisting of 5 protective covers in transparent plastic material, for button models 41PAM000, 43PAM000, 43PAE020 and 41PAE020.



**41SAI000**



**ADDRESSABLE INDOOR SIREN ON LOOP**

The 41SAI000 addressable siren, with built-in isolator, is powered from the loop and is controlled by the control panel by means of the communication protocol. The standard base is required for the mounting of 41RBX020 addressed detectors. Sounder also suitable for outdoor installations when used with IP65-rated base Art. 41BSE000. The siren is also fitted with a built-in isolator. **Approved to EN 54-3 and EN 54-17.**



**41SCI000**



**ADDRESSABLE INDOOR SIREN ON LOOP**

The 41SCI000 addressable siren with flashing light and built-in isolator, is powered from the loop and is controlled by the control panel by means of the communication protocol. The standard base is required for the mounting of 41RBX020 addressed detectors. Siren also suitable for outdoor installations when used with IP65-rated base Art. 41BSE000. The siren is also fitted with a built-in isolator. **Approved to EN54-3, EN 54-17, EN 54-23.**



**41SAB100**



**SOUNDER BASE**

The LOGIFIRE series 41SAB100 addressed sound base is a base with built-in sounder. A detector can be mounted directly on it, thereby reducing the installation space required. Powered directly by the control panel and controlled by means of communication protocol, it integrates 32 different tones and 2 sound levels that can be programmed from the control panel. Sound base with an evolved design, suitable for any type of installation, even in the most aesthetically demanding situations. Family feeling with all sensors in the new LOGIFIRE series by Comelit. Built-in isolator. **Approved to EN54-3 and EN54-17.**



**K41VAD100**



**BASE COMPOSED OF EN54-23 BEACON AND EN54-3 SOUND BASE**

Low profile base with EN54-23 certified optical signaling complete with EN54-3 certified acoustic signaling device. With the same characteristics as the 41RBX020 base, it integrates 3 white flashing lights arranged uniformly to ensure 360 ° visibility and audible signaling with adjustable volumes. Maximum absorption with flash and volume at high level 17mA. Total diameter: 160mm. Total height 32.5mm. Color white. **Approved to EN54-3 and EN54-23.**



**41SCB100**



**SOUNDER BEACON BASE**

The LOGIFIRE series 41SCB100 addressed base is a base with built-in siren and flashing light. A sensor can be mounted directly on it, thereby reducing the installation space required. Powered directly by the control panel and controlled by means of communication protocol, it integrates 32 different tones with 2 sound levels that can be programmed from the control panel and a red flashing light. Sound base with an evolved design, suitable for any type of installation, even in the most aesthetically demanding situations. Family feeling with all sensors in the new LOGIFIRE series by Comelit. Built-in isolator. **Approved to EN54-3 and EN54-17.**



## ADDRESSABLE RANGE LOOP DEVICES



### 41BSE000



PROTECTION  
RATING



### 41SAC000



### 48PIN001EN



### 4110M022 4110M022XL



EN54-13  
EN54-17  
EN54-18



MOD-  
ULES



MOD-  
ULES



PROTECTION  
RATING



### 4110M122 4110M122XL



EN54-13  
EN54-17  
EN54-18



MOD-  
ULES



MOD-  
ULES



PROTECTION  
RATING



### 4110M040 4110M040XL



EN54-13  
EN54-17  
EN54-18



MOD-  
ULES



PROTECTION  
RATING



### 4110M004 4110M004XL



EN54-13  
EN54-17  
EN54-18



MOD-  
ULES



PROTECTION  
RATING

### IP65 DEEP BASE FOR ADDRESSABLE SOUNDERS

Base IP65 for addressable sounders 41SAI000 and 41SCI000 with cable glands included.

### COVER FOR SOUNDER BASE

5 plastic covers for art. 41SAB000, 41SAB000/IS and 41SCB000.

### INDICATOR PANEL WITH "FIRE ALARM" TEXT

Indicator panel in transparent Plexiglass, including FIRE ALARM text label, with space dedicated to siren housing (41SCI000, 48SAI020, 48SCI040 and 48SCI060). Supplied with screws and spacers for fixing to a wall. Dimensions 350x140x5 mm.

### ADDRESSABLE MODULE WITH 2 INPUTS AND 2 OUTPUTS

The 4110M022 addressable module checks two balanced inputs and controls two relay outputs. It is powered from the loop and is controlled by the control panel by means of the communication protocol. The module comes in a plastic container which is suited to wall mounting; it has a transparent plastic cover for easy visual inspection. **Approved to EN 54-17 and EN 54-18.**

**4110M022XL:** Box dimensions (mm) 178 x 128 x 58. Color Grey, IP55.

**Approved to EN 54-17 and EN 54-18.**

### ADDRESSABLE MODULE WITH 2 INPUTS/2 OUTPUTS

The addressable module, with built-in on-board isolator, controls two balanced inputs and two monitored or relay-dependent outputs, on the basis of the position of the 2 jumpers inside the module. It is powered from the loop and is controlled from the control panel by means of the communication protocol. The module is supplied in a plastic enclosure suitable for wall-mounting, with a clear cover to allow easy visual inspection. **Approved to EN 54-17 and EN 54-18.**

**4110M122XL:** Box dimensions (mm) 178 x 128 x 58. Color Grey, IP55.

**Approved to EN 54-17 and EN 54-18.**

### ADDRESSABLE MODULE WITH 4 INPUTS

The addressable module 4110M040 controls four balanced inputs. It is powered from the loop and is controlled by the control panel by means of the communication protocol. The module comes in a plastic container which is suited to wall mounting; it has a transparent plastic cover for easy visual inspection. **Approved to EN 54-17 and EN 54-18.**

**4110M040XL:** Box dimensions (mm) 178 x 128 x 58. Color Grey, IP55.

**Approved to EN 54-17 and EN 54-18.**

### ADDRESSABLE MODULE WITH FOUR RELAY OUTPUTS

The 4110M004 addressable module controls four relay outputs. It is powered from the loop and is controlled by the control panel by means of the communication protocol. The module comes in a plastic container which is suited to wall mounting; it has a transparent plastic cover for easy visual inspection. **Approved to EN 54-17 and EN 54-18.**

**4110M004XL:** Box dimensions (mm) 178 x 128 x 58. Color Grey, IP55.

**Approved to EN 54-17 and EN 54-18.**



**41IOM000  
41IOM000XL**

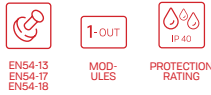

**ADDRESSABLE MODULE WITH 1 MONITORED OUTPUT**

The 41IOM000 addressed module with built-in isolator controls a voltage output for controlling audible and visual devices, electromagnetic door stops, etc. with a separate power supply. Terminals for 24 V users and separate 24 V max. 750 mA outputs. It is powered from the loop and is controlled by the control panel by means of the communication protocol. The module comes in a plastic container which is suited to wall mounting; it has a transparent plastic cover for easy visual inspection. **Approved to EN 54-17 and EN 54-18.**

**41IOM000XL:** Box dimensions (mm) 178 x 128 x 58. Color Grey, IP55.  
**Approved to EN 54-17 and EN 54-18.**



**41IOM000 /240  
41IOM000 /240XL**

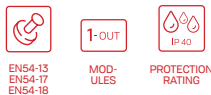

**ADDRESSABLE MODULE, 1 RELAY OUTPUT, 240VAC**

Addressable module 41IOM000/240, with integrated on-board isolator, provides a voltage-free relay output for control of devices with supply voltage of 250Vac (5A) or 30Vdc (5A). Powered from the loop and controlled from the control panel via the communication protocol. The module is supplied in a plastic enclosure suitable for wall-mounting, with a clear cover to allow easy visual inspection. **Approved to EN54-17 and EN 54-18.**

**41IOM000/240XL:** Box dimensions (mm) 178 x 128 x 58. Color Grey, IP55.  
**Approved to EN 54-17 and EN 54-18.**



**41ISC000  
41ISC000XL**

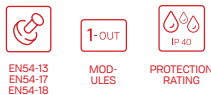

**ADDRESSABLE MODULE FOR CONVENTIONAL ZONE**

The 41ISC000 addressable module allows interfacing between the addressable fire detection system and a separately powered conventional zone. It is powered from the loop and is controlled by the control panel by means of the communication protocol. Separate 24 V terminals for line power supply. The module comes in a plastic container which is suited to wall mounting; it has a transparent plastic cover for easy visual inspection. **Approved to EN54-17 and EN 54-18.**

**41ISC000:** Box dimensions (mm) 178 x 128 x 58. Color Grey, IP55.  
**Approved to EN 54-17 and EN 54-18.**



**41IOM010**



**ADDRESSED MINI MODULE WITH 1 INPUT**

The 41IOM010 addressable module controls a monitored input to allow interfacing between the fire detection system and signals coming from other systems (e.g. gas or other detectors). The information sent to the control panel the moment the input is activated can be programmed for use in the way most suited to the specific application. The extremely compact size of the module means it can be installed directly in the device generating the input activation.



**41LED032**

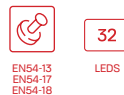

**32-LED MIMIC PANEL MODULE**

Addressed module with 32 Open collector outputs. Intended for the construction of synoptic panels. The module is installed on the loop and powered externally. It incorporates outputs for control panel status indication (Fire Alarm, Fault, Exclusions) and operational inputs such as: Silence sounder, Buzzer Silencing, Reset, Test and Command Lock. Housed in a grey plastic box with dimensions LxHxD (225x174x80). **Approved to EN 54-17 and EN 54-18.**



# THE CONVENTIONAL RANGE

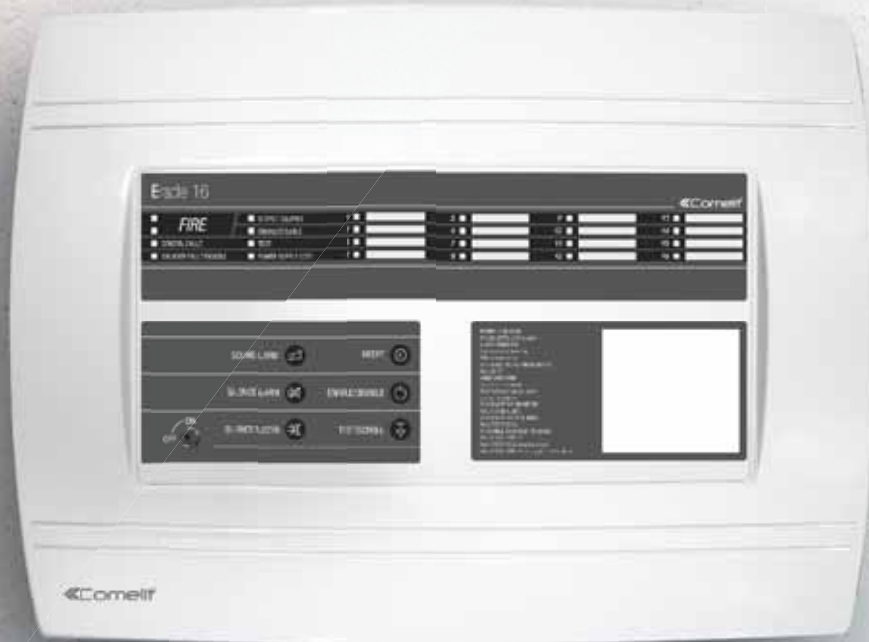

# ERACLE

## SIMPLE, SAFE AND RELIABLE

The range of conventional control panels in the ERACLE series offers the perfect solution for all small-scale installations in which the identification of individual points in alarm mode is not required.

The different configurations vary depending on the number of zones required. Each one of these may be connected to all the technologies used in the range of conventional detectors, MCP's or any other detection technology such as linear barriers, wireless systems, aspiration, etc.

For the signalling part, monitored outputs are available for all audio/visual, activation or inhibition signalling equipment, or anything else that needs to be managed from the control panel.

### APPLICATIONS



### ADVANTAGES





## CONVENTIONAL CONTROL PANELS

ERACLE series conventional control panels are the ideal solution for all small-scale applications which require a simple detection system offering a high level of security. The range fully conforms to standard EN54 and stands out due to the number of zones (2-4-8-16), providing a simple and intuitive user interface.

All indications are shown on the control panel by means of indicator lights which allow clear and immediate identification.

Each individual zone can be connected to all the devices in the conventional range or detection equipment with a relay output using the correct balance.

### 43CPC002EN

## ERACLE CONVENTIONAL CONTROL PANEL WITH 2 ZONES



ERACLE 2-ZONE is a conventional fire alarm control panel which supports up to 32 sensors or buttons for each detection line. It has a strong plastic container and displays all indications and commands on the front in compliance with the requirements set out by law. Indications for each Alarm and Fault line. Fire Alarm, Fault, Faulty/Disabled sounder, Disablements, Test and Mains Voltage general indications. Silence Buzzer, Silence Siren, Inclusion/Exclusion, Test, Reset and Audible Alarm commands. End-of-line impedance activated for continuous monitoring of the detection lines. Walk Test. Access levels protected by means of a secure key. 12 Vdc / 7 Ah secondary power supply battery.

Approved to EN 54-2 and EN 54-4.



EN54-2  
EN54-4



2 ZONES

### 43CPC004EN

## ERACLE CONVENTIONAL CONTROL PANEL WITH 4 ZONES



ERACLE 4-ZONE is a conventional fire alarm control panel which supports up to 32 sensors or buttons for each detection line. It has a strong plastic container and displays all indications and commands on the front in compliance with the requirements set out by law. Indications for each Alarm and Fault line. Fire Alarm, Fault, Faulty/Disabled sounder, Disablements, Test and Mains Voltage general indications. Silence Buzzer, Silence sounder, Enable/Disable, Test, Reset and Audible Alarm commands. End-of-line impedance activated for continuous monitoring of the detection lines. Walk Test. Access levels protected by means of a secure key. 12 Vdc / 7 Ah secondary power supply battery.

Approved to EN 54-2 and EN 54-4.



EN54-2  
EN54-4



4 ZONES

## 43CPC008EN ERACLE CONVENTIONAL CONTROL PANEL WITH 8 ZONES



ERACLE 8-ZONE is a conventional fire alarm control panel which supports up to 32 sensors or buttons for each detection line. It has a strong plastic enclosure and displays all indications and commands on the front in compliance with the requirements set out by law. Indications for each Alarm and Fault line, Fire Alarm, Fault, Faulty/Disabled sounder, Exclusion, Test and Mains Voltage general indications. Silence Buzzer, Silence sounder, Enable/Disable, Test, Reset and Audible Alarm commands. End-of-line impedance activated for continuous monitoring of the detection lines. Access levels protected by means of a secure key. Programmable detection mode with confirmation. Programmable siren activation delay. Can be expanded with 8-relay module. 12 Vdc / 7 Ah secondary power supply battery.

**Approved to EN 54-2 and EN 54-4.**



EN54-2  
EN54-4



8 ZONES

## 43CPC016EN ERACLE CONVENTIONAL CONTROL PANEL WITH 8-16 ZONES

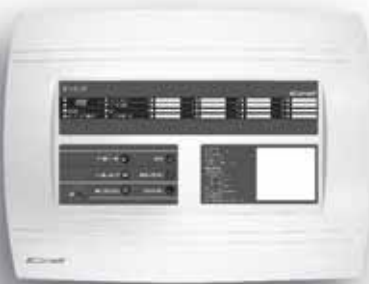

Eracle 8-16 is a conventional fire detection panel certified to EN54-2 and EN54-4 with 8 zones expandable up to 16 with 4 zones card art. 43ECZ020. The panel is provided with robust plastic cabinet and with LED display. It shows fire and faults alarm for each detection zone plus general information such as alarm, fault, sounder disable, zones disable, test, power. Commands available are test, sounder silence, reset, walk test. Access protected by key. 8 relays and 4 outputs for sirens cards can be installed as optional. If needed a LOG EVENT module can be installed to record up to 510 events. It is possible to connect another panel as repeater (SLAVE) to the MASTER to remote the indications up to 1Km.

**Approved to EN 54-2 and EN 54-4.**



EN54-2  
EN54-4



8 ZONES



## ACCESSORIES



### 43ECZ020



#### EXPANSION CARD WITH 4 ZONES FOR ERACLE 16

4 zones expander module for ERACLE 16. It is possible to connect up to 32 devices to each zone. Consumption in stand-by mode 130mA. Consumption in alarm 330mA. Dimensions 57x81mm. Weight 200g.



### 43ECS020



#### EXPANSION CARD WITH 4 SOUNDER CIRCUITS FOR ERACLE 16

4 sounder lines expander module for ERACLE 16. Consumption in alarm 150mA. Operating temperature 0°C to +40°C. Weight 200g. Dimensions 57x81mm.



### 43LEC000

#### EVENT LOG FOR ERACLE 16

Log Event for Eracle 16. Number of memory event 510. Nominal voltage 24Vdc. Consumption in stand-by mode 25mA. Consumption with activated backlight: 55mA±2mA. Maximum consumption with activated backlight and relay output: 76mA±2mA. Dimensions: 125x66mm.



### 43ECR032



#### EXPANSION MODULE 8 RELAY OUTPUTS FOR ERACLE 8/16

The 8 relay expansion module can be connected to the 8-zone ERACLE control panel 43CPC008 via serial port. Each relay is associated with a zone and will be activated in the event of a fire alarm being generated in that zone. Any siren activation delay set on the control panel will also be applied to the relays of module 43ECR032. Power supply voltage: 24 Vdc. Current consumption on standby: 8 mA. Additional consumption for each active relay: 10 mA. Maximum current consumption: 2 A. Contacts capacity: 1 A - 12 V or 0.5 A - 24 V. Cable cross-section: 1.5 / 2.5 mm<sup>2</sup>. Operating temperature -5°C / +40 C. Operating relative humidity: (93 ± 3) % - 40 °C. Dimensions:(HxLxD): 130x111x41 mm. Weight: 0.4 kg.



### 43EOL000

#### SET OF 5 EOL FOR CONVENTIONAL ZONE

Set of 5 end-of-line resistors for conventional zone.



### 43CRE000

#### SET OF 5 PAIRS OF KEYS FOR ERACLE CONTROL PANEL

Set of 5 pairs of keys for Eracle control panel.

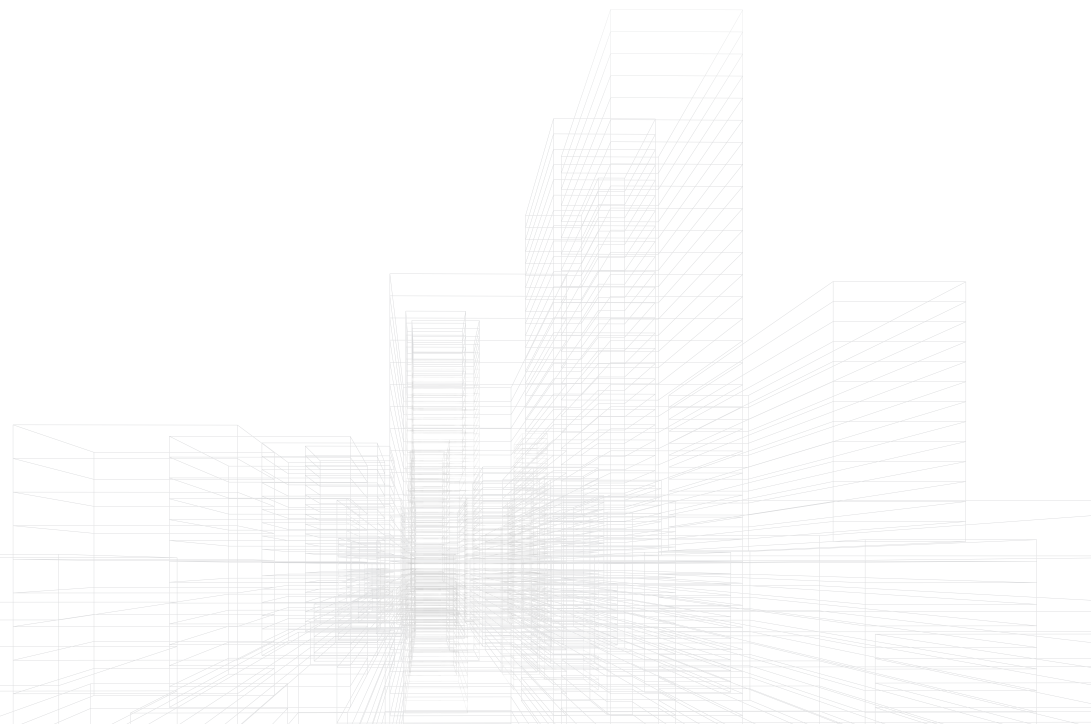



## CONVENTIONAL RANGE DEVICES



### 43RFU100



#### CONVENTIONAL OPTICAL SMOKE DETECTOR

The 43RFU100 detector is an optical smoke detector with a particularly sensitive digital algorithm for signal processing and can detect smoke even in the initial stages of a fire. Its detection features also make it suitable for application in environments such as offices and schools, supermarkets etc., where early fire detection is of fundamental importance. Microprocessor-controlled digital signal analysis. Low-profile design. Light indications via 2 LEDs which guarantee 360° visibility. Status indication every 8 seconds. **Approved to EN 54-7.**



### 43RCS100



#### CONVENTIONAL HEAT DETECTOR, THRESHOLD 58°

The 43RCS100 detector can detect the fixed threshold of 58°C in addition to rapid changes in temperature ("rate of rise") as set out by standard EN 54-5 for class A1R. The control algorithms implemented also mean it can be used in environments which are subject to ambient temperature changes; it is particularly useful for dusty or dirty environments or where the humidity level is high, factors which may negatively impact the performance of the optical sensors. Microprocessor-controlled digital signal analysis. Low-profile design. Light indications via 2 LEDs which guarantee 360° visibility. Status indication every 8 seconds. **Approved to EN 54-5.**



### 43RCS101



#### CONVENTIONAL HEAT DETECTOR, THRESHOLD 60°

The 43RCS101 detector can detect the fixed threshold of 60°C as set out by standard EN 54-5 for class A2S. The control algorithms implemented also mean it can be used in environments correctly subject to rapid and significant changes in temperature; it is particularly useful for dusty, dirty environments which may have a high concentration of steam and exhaust gases (e.g. garages, boiler rooms, kitchens, etc.). Microprocessor-controlled digital signal analysis. Low-profile design. Light indications via 2 LEDs which guarantee 360° visibility. Status indication every 8 seconds. **Approved to EN 54-5.**



### 43RCS102

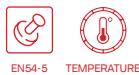

#### CONVENTIONAL HEAT DETECTOR, THRESHOLD 75°

Conventional detector with fixed threshold set to 75°C, as established by standard EN 54-5 for class B/S. The control algorithms implemented mean it can be used in environments subject to rapid and considerable changes in temperature and is particularly useful for applications in dusty environments, with a high concentration of vapours and exhaust gases (e.g. garages, boiler rooms, kitchens, etc.). Microprocessor-controlled digital signal analysis. Low-profile design. Light indications by means of 2 LEDs with 360° visibility. **Approved to EN 54-5.**



### 43RML100



#### CONVENTIONAL MULTI-CRITERIA DETECTOR

Detector 43RML100 is a multi-criteria detector combining the detection modes of the rate-of-rise detector 43RCS000 and the optical smoke detector 43RFU000, and is therefore particularly suited to applications where early fire detection must be ultra-reliable (hotels, museums, etc.). The detector triggers the alarm if the smoke or temperature threshold is exceeded; plus, if a sharp rise in temperature occurs, the smoke detection sensitivity is set to its maximum level. Microprocessor-controlled digital signal analysis. Low-profile design. Light indications via 2 LEDs which guarantee 360° visibility. Status indication every 8 seconds. **Approved to EN 54-5 and EN 54-7.**



### 48FPT100

#### REMOTE LED INDICATOR

The 48FPT100 remote LED repeater replicates the status of detectors in alarm mode. Compatible with the bases and detectors that support this function. Evolved design to guarantee an optimal solution for any type of installation, even in the most aesthetically demanding situations. Family feeling with the entire new range of LOGIFIRE sensors.



### 43RBX000

#### STANDARD CONVENTIONAL BASE

The standard base for conventional detectors has a low-profile design and an extremely reliable sensor connection system that provides a secure fixing for the detector. Dimensions: ø 102 mm, h 11 mm.



## CONVENTIONAL RANGE DEVICES



**43RBX001**

### CONVENTIONAL BASE WITH DIODE

The standard base with diode for conventional detectors has a low-profile design and an extremely reliable sensor connection system that provides a secure fixing for the detector. The diode senses when the detector is removed from its base. Dimensions:  $\varnothing$  102 mm, h 11 mm. Weight: 42 g.



**43RBX003**

### BASE WITH RELAY FOR CONVENTIONAL SENSORS

The base with relay for conventional detectors has a low-profile design and an extremely reliable sensor connection system that provides a secure fixing for the detector. The base is equipped with a 12 Vdc relay for interfacing with security systems. It can also operate in reset mode. Dimensions:  $\varnothing$  102 mm, h 11 mm. Weight: 46 g.



**43RBX004**

### CONVENTIONAL BASE WITH DIODE - 45MA HIGH CURRENT

Base with diode for conventional detectors with a low-profile design and an extremely reliable sensor connection system that provides a secure fixing for the detector. Compatible with fire alarm panels, where the current in alarm status is  $\geq 45$  mA. The diode senses when the detector is removed from its base. Dimensions ( $\varnothing$  x H): 102 x 11 mm. Weight: 42 g.



**43RBX005**

### TALL BASE FOR CONVENTIONAL DETECTORS

Standard tall base for conventional detectors, with extremely reliable system for connection to the sensor which also allows safety inhibiting of the detector. In addition to guaranteeing more space for routing and wiring cables, it also allows entry of external ducting directly into the base without the use of special spacers. Material: White ABS. Maximum cable cross-section: 2.00 mm<sup>2</sup>. Dimensions:  $\varnothing$  102 mm, h 25.3 mm. Weight 50 g.



**43RBA002**

### SPACER FOR CONVENTIONAL DETECTORS

The spacer enables the input of pipes for visible systems and the mounting of conventional and addressable sensors, sirens Art. 41SCB100, 41SAB100, 41SCB000, 41SAB000/IS, 48SAI020, 48SCIO40, 48SCIO60 on uneven surfaces, suspended ceilings, etc.



**43PAM000**



EN54-11

**CONVENTIONAL MANUAL CALL POINT**

Manual alarm point designed to be used in conventional firefighting systems. The manual call point is equipped with a resettable plastic key element (supplied) and sends an alarm signal to the control panel when it is activated by pressing the indicated point. It is equipped with frontal LED for signalling the alarm or test status. Resettable flexible element with special recovery key supplied. Wall mounting. Red ABS container. **Approved to EN54-11.**



**43PAE020**



EN54-11



PROTECTION RATING IP67

**CONVENTIONAL MANUAL CALL POINT IP67**

Manual call point with protection rating IP67, designed for use in conventional detection systems. The manual call point is equipped with a plastic recovery key (supplied) and, when it is activated by pressing the point indicated, it transmits an alarm signal to the panel. It has an LED at the front for indicating the alarm or test status. Resettable flexible element with special recovery key supplied. Wall mounting. Red ABS housing. **Approved in compliance with EN54-11.**



**43PAK000**

**SPARE KEY FOR FIRE BUTTONS**

Spare key for 41PAM000, 43PAM000, 41PAE020 and 43PAE020.



**43PAT000**

**PLASTIC COVER FOR MANUAL CALL POINT, SET OF 5**

Set consisting of 5 protective covers in transparent plastic material, for button models 41PAM000, 43PAM000, 43PAE020 and 41PAE020.



# THE WIRELESS RANGE



 Comelit®

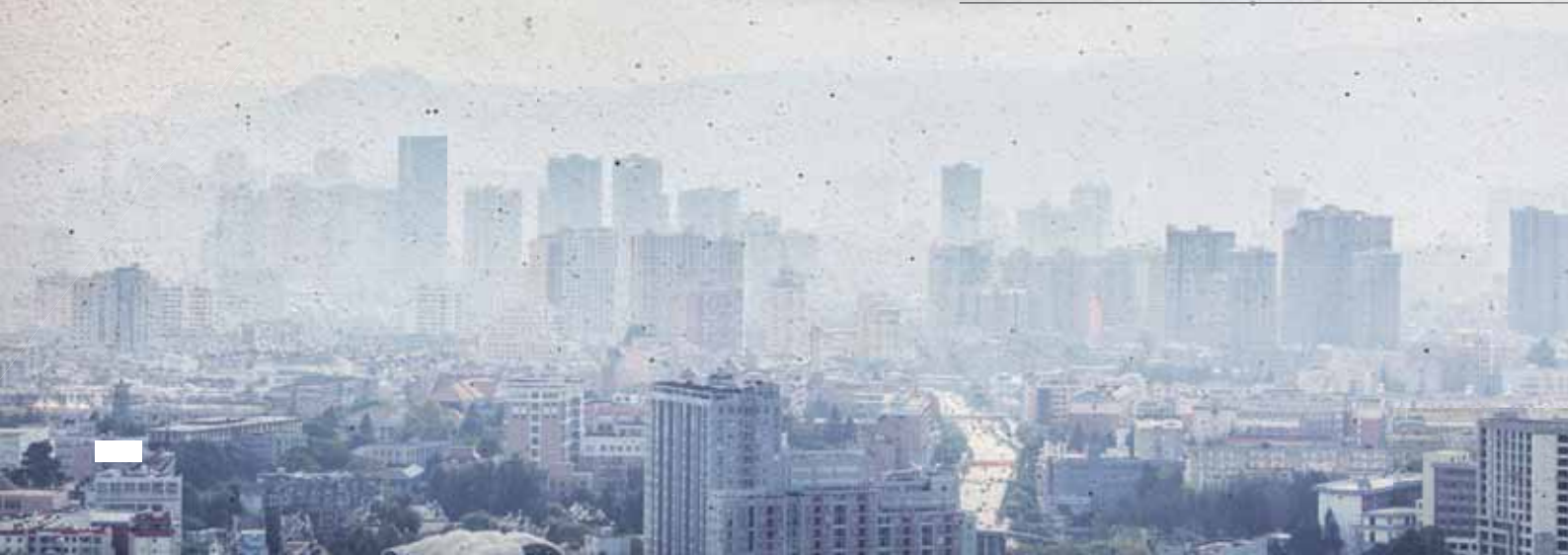

## WIRELESS REACHES THE PLACES WIRES CAN'T

Wireless fire technology allows the installation of detection and alarm equipment in areas without the necessary provision, or where architectural constraints do not allow wiring to take place.

Detection technologies are completely identical to conventional/addressable technologies, apart from the fact that all alarm, fault and test information is transmitted via a wireless signal. A perfect solution for historical sites, hospitality facilities and museums, which is capable of adapting to all situations in which wiring is not an option. All equipment is powered via dual battery, and monitored in two-way mode by the receiver unit.

### APPLICATIONS



### ADVANTAGES



WIRELESS



EN54-25



## WIRELESS RANGE DEVICES



### 45TRS000



### WIRELESS SIGNAL TRANSLATOR

The translator module allows interfacing between the conventional zone of the wired system and the wireless system. Communication via two-way radio guarantees excellent reliability. Automatic optimisation of the frequency and communication level, automatic channel selection. It can manage up to 32 devices via radio (sensors, buttons, sirens, etc.). Allows easy integration between radio systems and wired systems. Programmable from device or from a PC via RS232, by means of configuration software. **Approved to EN54-18 and EN54-25.**



### 45RPT000



### WIRELESS SIGNAL REPEATER

The wireless repeater module, connected to a translator module or another repeater module, makes it possible to extend the coverage area of the radio system, allowing installation of the wireless system in difficult environments. Two-way communication between the expander and translator guarantees optimum reliability. It is easily configured via RS232 using the configuration software, or via the keypad on the device itself. It automatically optimises the communication frequency and level; the channel is selected automatically. It can manage up to 32 devices via radio (sensors, buttons, sirens, etc.). External power supply.

**Approved to EN 54-18 and EN 54-25.**



### L-OP-SG



### WIRELESS OPTICAL SMOKE DETECTOR

Wireless optical Tyndall-effect smoke detector. The digital signal processing algorithms make it particularly sensitive to detecting smoke, even in the early stages of a fire breaking out. Two-way radio communication. Immediate transmission in the event of an alarm, fault or removal. Monitored dual battery for backup. Two-tone LED with 360° visibility. Option of conducting the test with a magnet. IP40 rating. **Approved to EN 54-7 and EN 54-25.** Base included.



### L-HT-SG



### WIRELESS HEAT DETECTOR

Wireless heat detector. Can detect the fixed threshold of 58°C in addition to rapid changes in temperature ("rate of rise") as set out by standard EN 54-5 for class A1R. The control algorithms implemented also mean it can be used in environments which are subject to ambient temperature changes; it is particularly useful for dusty or dirty environments or where the humidity level is high, factors which may negatively impact the performance of the optical sensors. Two-way radio communication. Immediate transmission in the event of an alarm, fault or removal. Monitored dual battery for backup. Two-tone LED with 360° visibility. Option of conducting the test with a magnet. IP40 rating. **Approved to EN 54-5 and EN 54-25.** Base included.



### L-MC-SG



### WIRELESS MULTI-CRITERIA DETECTOR

Wireless multi-criteria detector. Combines the detection modes of a heat detector and an optical smoke detector, and is therefore particularly suited to applications where early fire detection must be ultra-reliable (hotels, museums, etc.). The detector signals the alarm if the smoke or temperature threshold is exceeded. Two-way radio communication. Immediate transmission in the event of an alarm, fault or removal. Monitored dual battery for backup. Two-tone LED with 360° visibility. Option of conducting the test with a magnet. IP40 rating.

**Approved to EN 54-5, EN 54-7 and EN 54-25.** Base included.



### 45FPT000



### WIRELESS LED REPEATER

The remote indicator repeats the status of the wireless detectors. Compatible with sensors that support this function. Two-way radio communication, monitored dual battery for backup. Operating temperature -10°C / +55°C. Weight 130 g. Dimensions: 145 x 66 mm.



### SGCP200



### WIRELESS MANUAL ALARM BUTTON

Wireless manual call point. The button is equipped with a special resettable plastic key element (supplied) and sends an alarm signal when it is activated by pressing the indicated point. It has a two-tone LED for status indication. Two-way radio communication. Wall mounting. Dual battery, main and backup (2 x CR123). Instant transmission of alarms, faults and removal. Operating temperature -10°C / +55°C. Weight 160 g. Dimensions 88x87x61 mm.

**Approved to EN 54-11 and EN 54-25.**



**45PAK001**

**SPARE KEY FOR WIRELESS BUTTON SGCP200**

Spare key for wireless manual button Art. SGCP200.



**45SAI020**

**WIRELESS SOUNDER**

Wall-mounted siren, to be completed with module 45MOD000, which makes it suitable for use in wireless systems with EN54-25 approval; the siren has 3 volume adjustment levels and 32 different tones which can be set locally via dip-switch. Sound power 100db.

**Approved to EN54-3.**



**45SCI000**

**WIRELESS SIREN WITH BEACON**

Siren with strobe for wall mounting. To be completed with module 45MOD000, which makes it suitable for use in wireless systems with EN54-25 approval. Equipped with dip-switches for selecting one of the 32 available tones, with the option of setting the flashing frequency between 0.5 Hz and 1 Hz. IP65 protection rating. **Approved to EN54-3 EN54-23.**

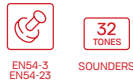

**45MOD000**

**BOARD FOR WIRELESS SOUNDERS**

RF transceiver module for installation inside wireless sirens to allow communication with translators/repeaters. Maximum distance between the translator/repeater and the module 150 m. Main battery lifespan: 5 years. Secondary battery lifespan: 2 months.

**Approved to EN54-18 and EN54-25.**



**SGRBS100/L**

**WIRELESS SOUNDER BASE**

Base with wireless siren with two-way radio communication. Suitable for housing a wireless detector. Monitored dual battery for backup. Immediate transmission in the event of an alarm, fault or sensor removal. 32 tone options. Max. sound power 95 dBa. Communication distance in open air 200 m. Weight: 150 g. Dimensions: 120x52 mm. **Approved to EN54-3, EN 54-25.**



**45SAC000**

**COVER FOR WIRELESS SOUNDER BASE**

Cover to be applied to the base with siren SGRBS100/L if a detector is not fitted.



**SGMI200**

**MODULE WITH 1 INPUT VIA RADIO**

Wireless module with 1 input, allows monitoring and subsequent status (ON/OFF) transmission of an external device. Connection between the module and the device is constantly monitored thanks to an end of line resistor. Equipped with a main and backup battery, to guarantee an average module life of around 7 years (normal operating conditions). Up to 200 m open field communication distance between the module and the translator/repeater. IP65 protection rating.



**SGMCB200**

**MODULE WITH 1 OUTPUT VIA RADIO**

This Wireless module can be used to activate / deactivate devices connected to its output. The module also allows monitoring of the line from short-circuit or cut-off events. Equipped with 2 x CR123A batteries, one main and one backup. Up to 200 m open field communication distance between the module and the translator/repeater. IP65 protection rating.





# THE EXTINGUISHING RANGE





## EXTINGUISHING CONTROL PANELS TAKE ACTION BEFORE IT'S TOO LATE

The extinguishing panels are designed to manage all logics and timescales relating to automatic extinguishing systems protecting DPCs, Archives, Technical sites or anywhere it is necessary to actively safeguard the contents without creating disruption.

The extinguishing part can be entrusted to conventional technologies or, where appropriate, employed through communication with addressable panels.

### APPLICATIONS



### ADVANTAGES



EN54-2  
EN54-4  
EN12094-1



## EXTINGUISHING RANGE

46EST003

EXTINGUISHANT CONTROL PANEL



Conventional fire extinguishing system control panel with 3 wired zones (2 fire extinguishing and 1 alarm) designed for use in combination with active fire extinguishing systems. Can be combined with events log module 46LEP000 (optional)



EN54-2  
EN54-4  
EN12094-1

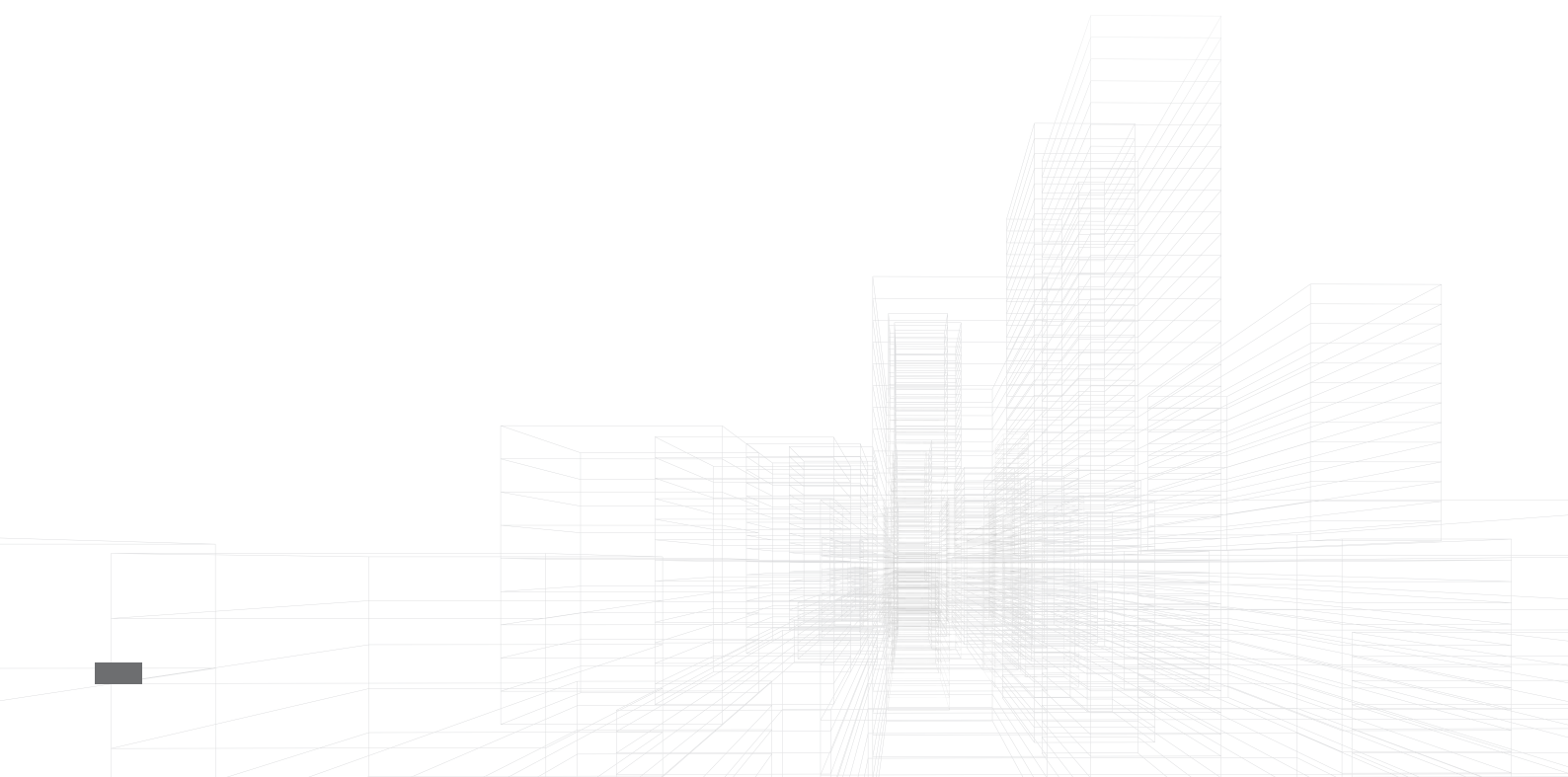

ACCESSORIES



**46LEP000**

**EVENT LOG FOR EXTINGUISHANT CONTROL PANEL**

Optional module for recording and viewing the events log of the fire extinguishing system control panel 46EST003; provides the possibility to store up to 1000 events.



**46PMA100**

**YELLOW BUTTON FOR EXTINGUISHING ACTIVATION**

Yellow manual button for forced activation of the shutdown process in the protected area. Pressing the flexible element starts shutdown process activation. Features a protective transparent cover to prevent unwanted activation; reset key supplied. Dimensions (LxHxD mm) 94x92x60. Material: ABS. Protection rating IP40.



**46PMS120**

**BLUE BUTTON FOR EXTINGUISHING SYS. DEACTIVATION**

Blue manual button for temporarily stopping the shutdown process. Pressing this button stops and delays the shutdown process in the protected area of the site, with a time pre-programmed on the control panel. Features a protective transparent cover to prevent unwanted button activation. Dimensions (LxHxD mm) 94x92x60. Material: ABS. IP40 protection rating.



**48CTS020**

**MAGNETIC CHANGEOVER CONTACT WITH TERMINAL**

Magnetic contact for visible installation on doors, windows and REI fire doors. Connection takes place via 5 internal terminals with NO/NC changeover contact. The package includes screws for fixing the contact and push-fit screw covers. The operating distance of 25 mm in open air guarantees optimal operation on all surfaces.

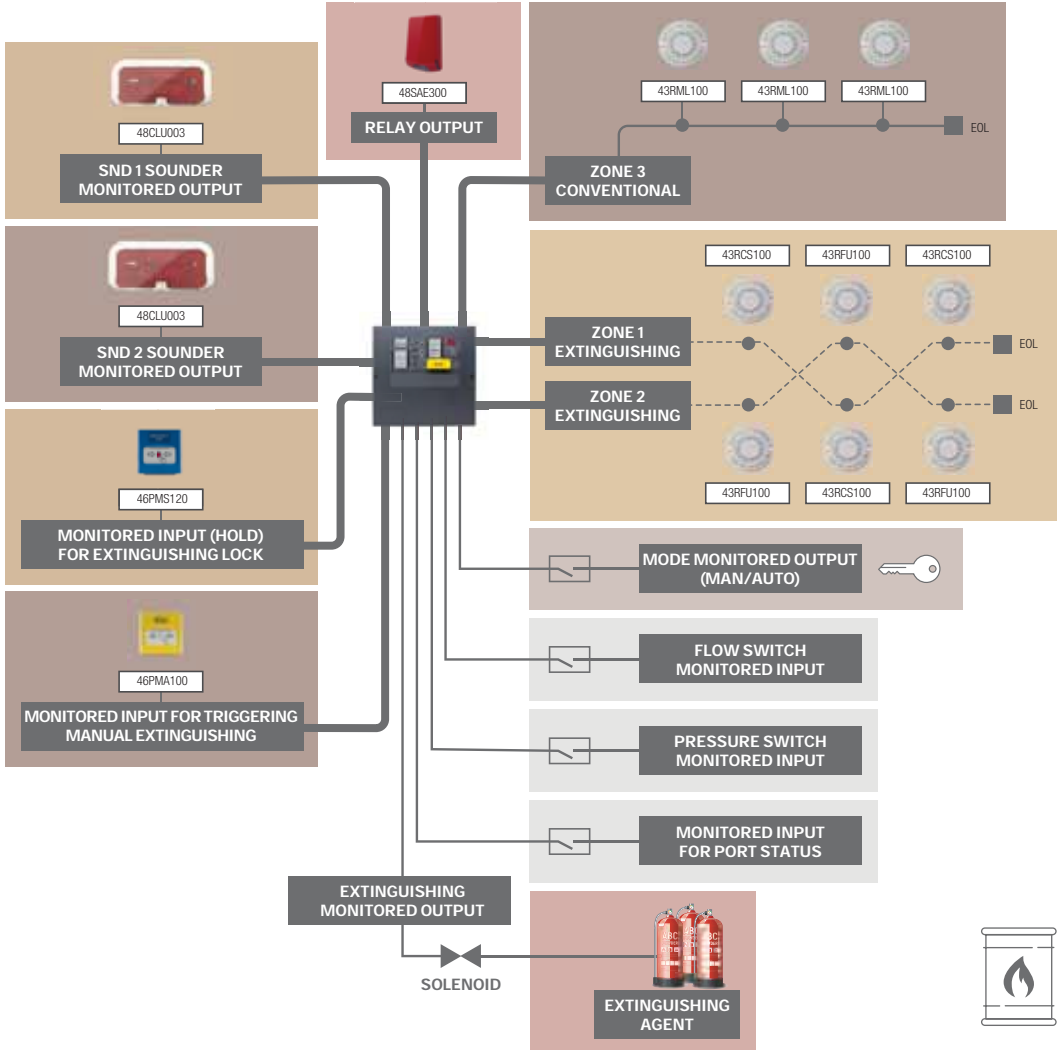



# THE SIGNALLING **DEVICES RANGE**



 **Comelit®**

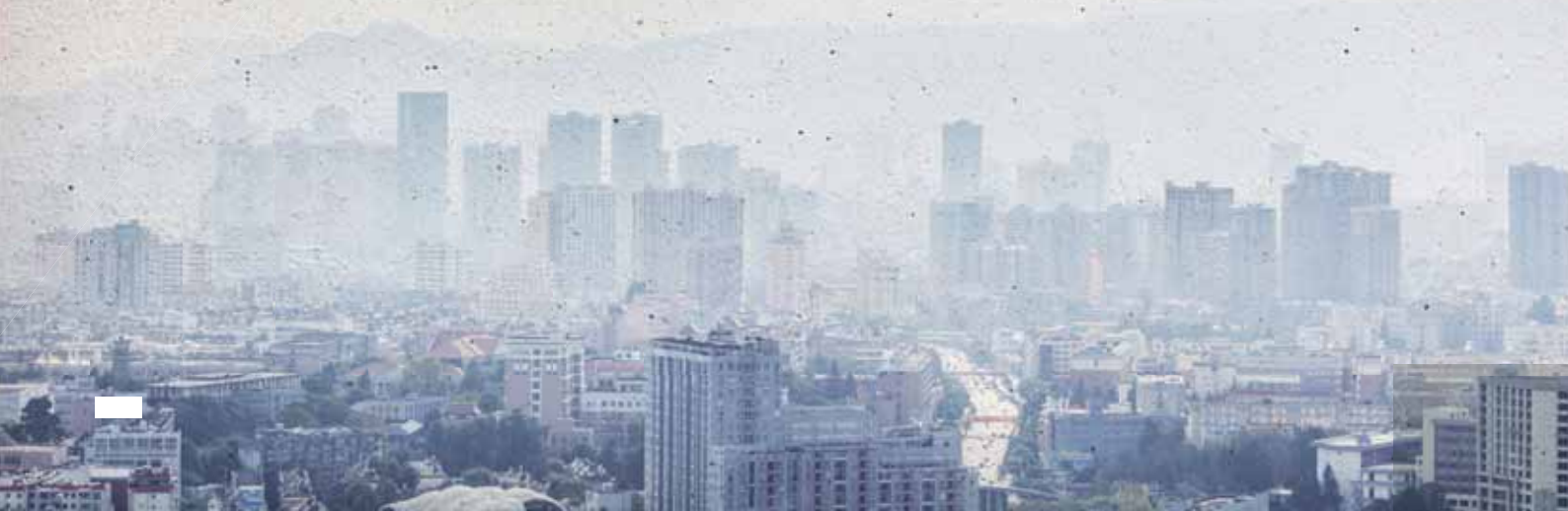

## SIGNALLING DEVICES ALERTS TO ENSURE YOUR SAFETY

A complete range of devices for the audio-visual signalling of fire alarm events. They can be made to communicate with conventional or addressable control panels depending on the type requested in the design phase, audio only, visual, wall- or ceiling-mounted, for indoor or outdoor installation.

### APPLICATIONS



### ADVANTAGES



EN54-3  
EN54-23

32  
TONES

SOUNDERS



## CONVENTIONAL SIGNALLING RANGE DEVICES



### 48SAE300



EN54-3



SOUNDERS



SOUNDERS



PROTECTION RATING

### CONVENTIONAL OUTDOOR SOUNDER, EN54-3

Conventional IP44 outdoor siren, IP54 electronics part protection, equipped with strobe (2 high-efficiency LEDs), red plastic material, power supply voltage 20-30 VDC, absorption 28 mA@24 V. Sound power 95 dB@1 m. Approved to EN54-3. Dimensions: H=310 mm, L=230 mm, P=60 mm.



### 48CLU003



EN54-3  
EN54-23



SOUNDERS



SOUNDERS



PROTECTION RATING

### AUDIO-VISUAL WARNING SIGN EN54 3/23

Audiovisual indicator sign. Approved to EN 54-3 and EN 54-23.



### 48CLU006

INTERCHANGEABLE "FIRE ALARM" TEXT FOR VISUAL/AUDIBLE SIGN 48CLU003



### 48CLU007

INTERCHANGEABLE "EVACUATE IMMEDIATELY" TEXT FOR OPTICAL/AUDIBLE SIGN 48CLU003



### 48CLU008

INTERCHANGEABLE "DO NOT ENTER GAS RELEASED" TEXT FOR OPTICAL/AUDIBLE SIGN 48CLU003



### 48SAE000



EN54-3



SOUNDERS



SOUNDERS



PROTECTION RATING

### ELECTRONIC SOUNDER - IP66 EN54

Low-energy, high-volume outdoor siren with 32 tone options. Max. sound power 110 dB at 1 m. Max. consumption 39 mA. IP66 protection rating (mounting backplate art. 48SAE001 for IP66 rating not included). Supply voltage 9-30 V DC. Dimensions: 92 mm (diameter) x 95 mm. Approved to EN 54-3.



### 48SAE001



PROTECTION RATING

### BACKPLATE FOR 48SAE000 SOUNDER IP66 MOUNTING

Mounting backplate for the sounder 48SAE000 with IP66 protection rating.



### 48SAI050



EN54-3



SOUNDERS



SOUNDERS



PROTECTION RATING

### INDOOR SIREN WITH STROBE

Conventional fire protection sounder with red strobe, equipped with an input for connection to a conventional or addressed control panel using an output module. Compact siren designed for indoor use and surface mounting. Easy and quick installation without having to remove any siren components, with the unit secured using a single screw. Power supply voltage 16-29 VDC, maximum absorption 75 mA (24 Vdc). Maximum sound power 102 dB° @ 1 m. Material: red ABS. Dimensions (LxHxD) 69x94x45. Weight 77 g. Protection rating IP21C.

Certification according to EN54-3.



### 48SAI020



EN54-3



SOUNDERS



PROTECTION RATING

### INDOOR 32-TONE SOUNDER

Conventional fire alarm sounder with 32 different alarm tone types selectable via DIP switches on the PCB. The sounder has two inputs for connection to a conventional fire alarm panel: "Alarm" and "Evacuation". The tone sounds of the inputs are different for easy recognition from the users on the protected site. The Evacuation event is with the highest priority. The sounder is easy for installation and consists of three parts: mounting plane basis, sounder body and a plastic red cover. Certification according to EN54-3.

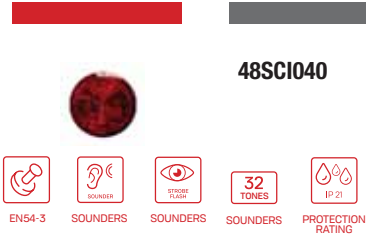

#### 48SCI040

#### SOUNDER WITH RED BEACON

Conventional wall mount sounder with red strobe, designed for installing in conventional fire alarm systems. Supports 32 different tone types and two sound levels, controlled by jumpers. The device is equipped with two additional separate inputs for Alarm and Evacuation events. The tone sounds of the inputs are different for easy recognition from the users on the protected site. The Evacuation event is with the highest priority. **Certified according to standard EN54-3.**



#### 48SCI060

#### SOUNDER WITH WHITE BEACON

Conventional fire alarm sounder with a strobe. The sounder supports 32 different alarm tone types selectable via DIP switches on the PCB. The sounder has two inputs for connection to a conventional fire alarm panel: "Alarm" and "Evacuation". In case the two inputs are used, the "Evacuation" input always has a priority in activation. Is designed for indoor use only. The sounder is easy for installation and consists of three parts: mounting plane basis, sounder and strobe combined in a common body and a plastic transparent cover. **The conventional sounder is certified according to standards EN54-3 and EN54-23.**



#### 43RBA002

#### SPACER FOR CONVENTIONAL DETECTORS

The spacer enables the input of pipes for visible systems and the mounting of conventional and addressable sensors, sirens Art. 41SCB100, 41SAB100, 41SCB000, 41SAB000/IS, 48SAI020, 48SCI040, 48SCI060 on uneven surfaces, suspended ceilings, etc.



#### 43RBR003

#### SPACER FOR FIRE SOUNDERS, RED

The spacer allows the input of trunking/conduit for visible systems, as required for the installation of red FIRE sounders Art. 48SAI020 and 48SCI040



#### 48PIN001EN

#### INDICATOR PANEL WITH "FIRE ALARM" TEXT

Indicator panel in transparent Plexiglass, including FIRE ALARM text label, with space dedicated to siren housing (41SCI000, 48SAI020, 48SCI040 and 48SCI060). Supplied with screws and spacers for fixing to a wall. Dimensions 350x140x5 mm.



## CONVENTIONAL SIGNALLING RANGE DEVICES



### 48SCE000



EN54-3  
EN54-23



SOUNDER



SOUNDER



SOUNDER



SOUNDER



32  
TONES



### 48SCE020



EN54-3  
EN54-23



SOUNDER



SOUNDER



SOUNDER



32  
TONES



### 48SCI000



EN54-3  
EN54-23



SOUNDER



SOUNDER



SOUNDER



32  
TONES



### 48SCI020



EN54-3  
EN54-23



SOUNDER



SOUNDER



SOUNDER



32  
TONES



### 48LME000



EN54-23



SOUNDER



SOUNDER



IP 65



### 48LME020



EN54-23



SOUNDER



SOUNDER



IP 65



### 48LMI000



EN54-23



SOUNDER



SOUNDER



IP 21



### 48LMI020



EN54-23



SOUNDER



SOUNDER



IP 21

### CEILING-MOUNTED SOUNDER BEACON, IP65

Visual and audible warning device for fire alarm systems. Ceiling-mounted. Coverage (C) 3 m x 15 m. Low-energy white flash LED. Sound power 94-97 dB(A). Absorption 25 mA with 0.5 Hz frequency, 45 mA with 1 Hz frequency. IP65 protection rating. Dimensions: 100 mm (diameter) x 117 mm. **Approved to EN 54-3 and EN 54-23.**

### WALL-MOUNTED SOUNDER BEACON, IP65

Visual and audible warning device for fire alarm systems. Wall mounting. Coverage (W) 3.1 m x 11.3 m. Low-energy white flash LED. Sound power 94-97 dB(A). Absorption 25 mA with 0.5 Hz frequency, 45 mA with 1 Hz frequency. IP65 protection rating. Dimensions: 100 mm (diameter) x 117 mm. **Approved to EN 54-3 and EN 54-23.**

### CEILING-MOUNTED SOUNDER BEACON, IP21

Visual and audible warning device for fire alarm systems. Ceiling-mounted. Coverage (C) 3 m x 15 m. Low-energy white flash LED. Sound power 94-97 dB(A). Absorption 25 mA with 0.5 Hz frequency, 45 mA with 1 Hz frequency. IP21 protection rating. Dimensions: 100 mm (diameter) x 100 mm. **Approved to EN 54-3 and EN 54-23.**

### WALL-MOUNTED SOUNDER BEACON, IP21

Visual and audible warning device for fire alarm systems. Wall mounting. Coverage (W) 3.1 m x 11.3 m. Low-energy white flash LED. Sound power 94-97 dB(A). Absorption 25 mA with 0.5 Hz frequency, 45 mA with 1 Hz frequency. IP21 protection rating. Dimensions: 100 mm (diameter) x 110 mm. **Approved to EN 54-3 and EN 54-23.**

### CEILING-MOUNTED BEACON, IP65

Visual warning device for fire alarm systems. Ceiling-mounted. Coverage (C) 3 m x 15 m. Low-energy white flash LED. Absorption 20 mA with 0.5 Hz frequency, 40 mA with 1 Hz frequency. IP65 protection rating. Dimensions: 100 mm (diameter) x 117 mm. **Approved to EN 54-23.**

### WALL-MOUNTED BEACON, IP65

Visual warning device for fire alarm systems. Wall mounting. Coverage (W) 3.1 m x 11.3 m. Low-energy white flash LED. Absorption 20 mA with 0.5 Hz frequency, 40 mA with 1 Hz frequency. IP65 protection rating. Dimensions: 100 mm (diameter) x 117 mm. **Approved to EN 54-23.**

### CEILING-MOUNTED BEACON, IP21

Visual warning device for fire alarm systems. Ceiling-mounted. Coverage (C) 3 m x 15 m. Low-energy white flash LED. Absorption 20 mA with 0.5 Hz frequency, 40 mA with 1 Hz frequency. IP21 protection rating. Dimensions: 100 mm (diameter) x 100 mm. **Approved to EN 54-23.**

### WALL-MOUNTED BEACON, IP21

Visual warning device for fire alarm systems. Wall mounting. Coverage (W) 3.1 m x 11.3 m. Low-energy white flash LED. Absorption 20 mA with 0.5 Hz frequency, 40 mA with 1 Hz frequency. IP21 protection rating. Dimensions: 100 mm (diameter) x 110 mm. **Approved to EN 54-23.**





**48CME000**



EN54-3



SOUNDERS



PROTECTION RATING

**6" OUTDOOR BELL 24 V DC 12 mA EN54**

Low-energy, high-volume aluminium outdoor bell. Sound power 95 dB(A). Consumption 20 mA. IP55 protection rating. Supply voltage 19-28 V DC. Dimensions: 150 mm (diameter) x 98 mm. Comes with a junction box for wall mounting, with a dual inlet hole. **Approved to EN 54-3.**



**48CMI000**



EN54-3



SOUNDERS



PROTECTION RATING

**6" INDOOR BELL 24 V DC 12 mA EN54**

Low-energy, high-volume aluminium indoor bell. Sound power 95 dB(A). Consumption 11 mA. IP33C protection rating. Supply voltage 19-28 V DC. Dimensions: 150 mm (diameter) x 64 mm. **Approved to EN 54-3.**

**UNI 11744:2019 - PATTERN OF UNIFIED ACOUSTIC FIRE ALARM AND PRE-ALARM SIGNAL**

In force since April 2019, this specifies the pattern of the unified acoustic evacuation alarm and pre-alarm signal, used in acoustic fire detection and alarm devices.

- Acoustic pre-alarm signal: consists of an alternating sawtooth sound with a frequency variation from 800 to 970 Hz and a variation duration of 1 second.
- Acoustic evacuation alarm signal: consists of a continuous sound at 970 Hz  $\pm$  50 Hz.

**VISUAL FIRE ALARM DEVICES - UNI EN54-23:**

**OPTICAL RANGE OF A SIGNALLING UNIT FOR WALL INSTALLATION:**

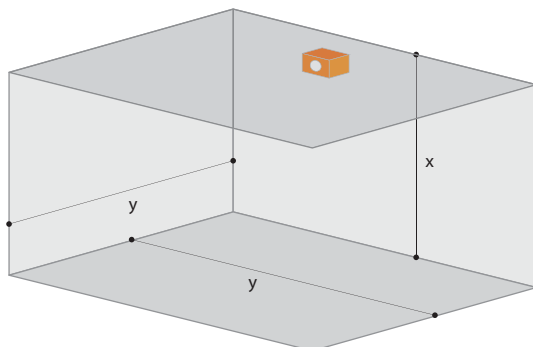

**OPTICAL RANGE OF A SIGNALLING UNIT FOR CEILING INSTALLATION:**

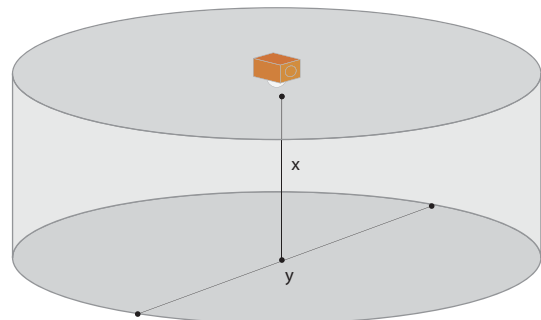



# THE ASPIRATING RANGE



 Comelit®



# ASPIRATION

## DETECT IN ADVANCE, BUT DISCREETLY

The technology applied to aspirating systems allows early detection of potential alarm causes through a complex and sophisticated air sampling process.

The analysis unit pairs the aspiration system with highly sensitive detectors capable of detecting very low percentages of smoke that may be present in a room.

Early detection allows the system to intervene at the very start of combustion, to prevent the fire from spreading. Calculation software can be used to size the pipes and the cross-section of holes correctly, in order to guarantee the category requested for the project. A full range of accessories allows quick and easy installation.

## APPLICATIONS



## ADVANTAGES

- 1  
CHANNEL

ASD  
ASPIRATING
- 2  
CHANNELS

ASD  
ASPIRATING
- 36  
HOLES

ASD  
ASPIRATING
- EN54-20
- CLASS  
A

ASD  
ASPIRATING
- CLASS  
B

ASD  
ASPIRATING
- CLASS  
C

ASD  
ASPIRATING



## ASPIRATING SYSTEM CONTROL PANELS

IFT-P

ASPIRATING SMOKE DETECTOR, 1 ZONE



2-channel - 1-zone aspiration system. Size of the mass of smoke particles with nephelometric principle, Laser sensor. 2 x 100 metres of piping. 4 freely programmable alarm thresholds (Alert, Action, Fire1, Fire2). Detection field: 0.01% - 20% Osc /mt. Reading resolution: 0.01%. 1 shared fault relay (SPDT), 4 relays for each programmable threshold: Alert, Action, Fire1, Fire2 (SPDT). Power supply 24 Vdc - min 500 mA - max. 1.2 A. Programmable trigger delays. **Approved to EN54-20.** A Classes (12 holes), class B (36 holes), class C (36 holes).



EN54-20

2  
CHANNELS

ASD  
ASPIRATING

CLASS  
A

ASD  
ASPIRATING

CLASS  
B

ASD  
ASPIRATING

CLASS  
C

ASD  
ASPIRATING

36  
HOLES

ASD  
ASPIRATING



BIM

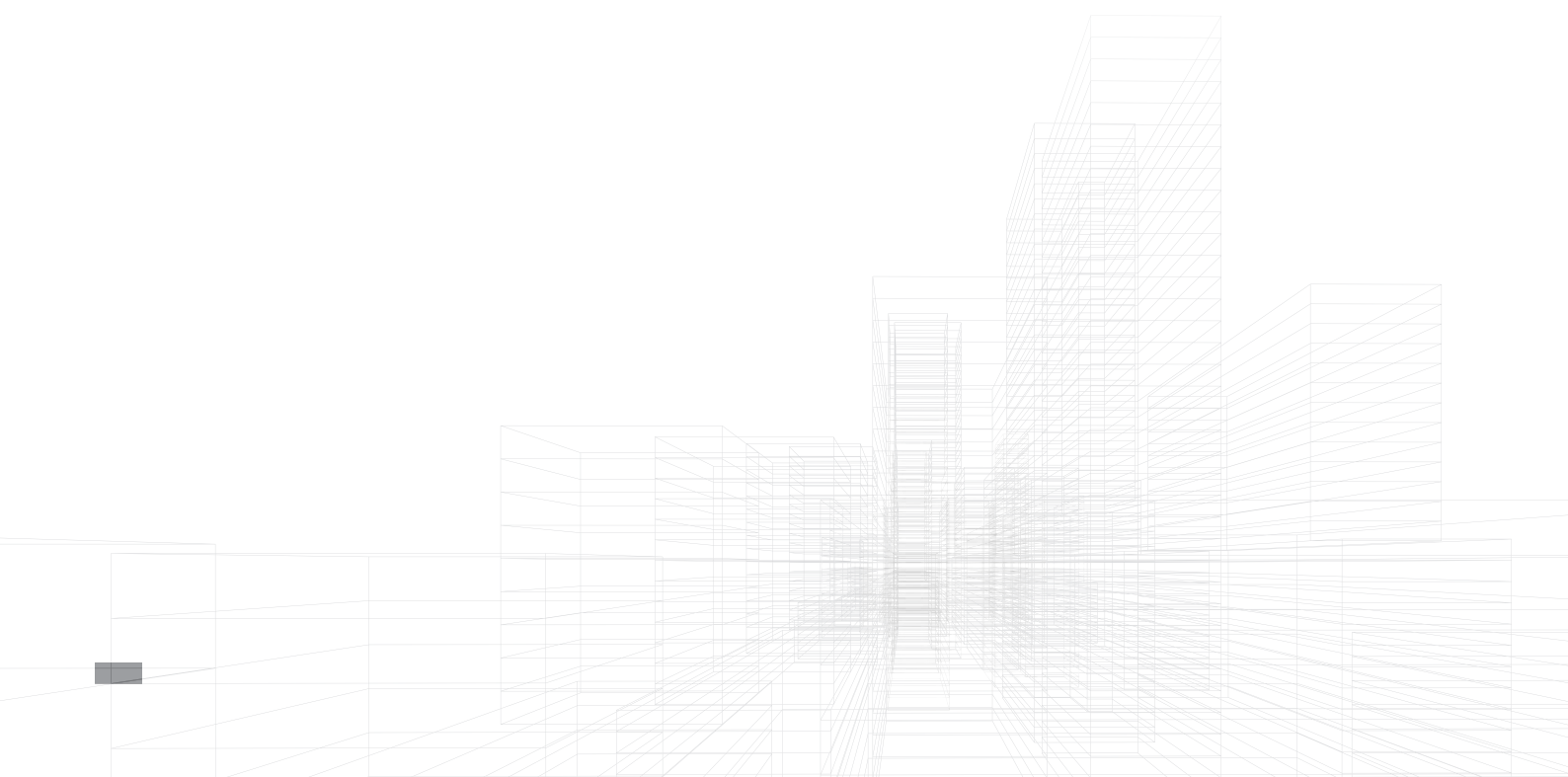

## ILS-1 ASPIRATING DETECTOR, 1 ZONE



1-channel aspiration system. Complete with high-sensitivity dual detector. 100 metres of piping. 3 relay outputs (Pre-alarm, Alarm, Fault). Power supply 24 Vdc - max. 300 mA. LED display indicating the concentration of smoke in each pipe. Quick start keys (no programming software required). **Approved to EN54-20.** A Classes (3 holes), class B (6 holes), class C (18 holes).



EN54-20



1 CHANNEL  
ASD ASPIRATING



CLASS A  
ASD ASPIRATING



CLASS B  
ASD ASPIRATING



CLASS C  
ASD ASPIRATING



18 HOLES  
ASD ASPIRATING



## ILS-2 ASPIRATING DETECTOR, 1 ZONE



2-channel aspiration system. Complete with high-sensitivity dual detector. Specification of the individual channel in alarm. 100 metres of piping per channel. 6 relay outputs (3 for channel Pre-alarm, Alarm, Fault). Power supply 24 Vdc - max. 300 mA. LED display indicating the concentration of smoke in each pipe. Quick start keys (no programming software required). **Approved to EN54-20.** A Classes (6 holes), class B (12 holes), class C (36 holes).



EN54-20



2 CHANNELS  
ASD ASPIRATING



CLASS A  
ASD ASPIRATING



CLASS B  
ASD ASPIRATING



CLASS C  
ASD ASPIRATING



18 HOLES  
ASD ASPIRATING



BIM





## ACCESSORIES



**PIP-001**

**RED ABS 25 MM PIPE, 20X 3 METRES**

20x 3 metre lengths of RAL3000 ABS 25 mm pipe.



**PIP-002**

**CONNECTION SOCKET FOR 25MM PIPE (10 PCS)**

Connection socket for 25mm pipe (10 pieces)



**PIP-003**

**SOCKET UNION FOR 25MM PIPE (10 PCS)**

Socket union for 25mm pipe (10 pieces)



**PIP-005**

**90 ELBOW FOR 25MM PIPE (10 PCS)**

90° elbow for 25mm pipe (10 pieces)



**PIP-006**

**45 ELBOW FOR 25MM PIPE (10 PCS)**







45° elbow for 25mm pipe (10 pieces)



**PIP-007**

**END CAP FOR 25MM PIPE (10 PCS)**

End cap for 25mm pipe (10 pieces)

	<b>PIP-008</b>	<b>EQUAL TEE FOR 25MM PIPE (10 PCS)</b> Equal Tee for 25mm pipe (10 pieces)
	<b>PIP-009</b>	<b>CLIP FOR 25MM PIPE (20 PCS)</b> Clip for 25mm pipe (20 pieces)
	<b>PIP-014</b>	<b>PIPE CUTTERS</b> Pipe cutters (1 piece)
	<b>PIP-015</b>	<b>FLUSH SAMPLE POINT HEAD FOR CAPILLARY PIPE</b> Flush sample point head for capillary pipe (1 piece)
	<b>PIP-016</b>	<b>TEE ADAPTER FOR CAPILLARY PIPE (10 PCS)</b> Tee adapter for capillary pipe (10 pieces).
	<b>PIP-021</b>	<b>25MM FLEXIBLE CONNECTOR, 100 CM</b> 25mm flexible connector, 100 cm (1 piece).



## ACCESSORIES

	<b>PIP-025</b>	<b>WATER FILTER WITH TRANSPARENT PIPE AND VALVE</b> Water trap with clear pipe and ball valve (1 piece).
	<b>PIP-026</b>	<b>25MM FLEXIBLE CONNECTOR, 30 CM</b> 25mm flexible connector, 30 cm (1 piece).
	<b>PIP-027</b>	<b>REMOTE SAMPLING TEST POINT FOR CAPILLARY TUBE</b> Remote sampling test point for 10 mm capillary tube (1 piece).
	<b>COLL250</b>	<b>ADHESIVE FOR PIPES AND SOCKETS 250ML</b> Adhesive for bonding pipes and fittings. Supplied with applicator brush. Contents: 250ml.
	<b>VSP-850-R</b>	<b>25MM IN-LINE EXTERNAL FILTER - RED</b> 25 mm external in-line filter - Red - to be used for installation of aspirating detectors in contaminated environments such as sawmills, scrapyards, etc.. The internal filter elements must be replaced periodically.
	<b>VSP-855-4</b>	<b>REPLACEMENT FOR FILTER VSP-850-R - 4 PIECES</b> Replacement filter elements for external in-line filter VSP-850. Pack of 4 filter elements.
	<b>ISP-001</b>	<b>REPLACEMENT FILTER ELEMENT, ILS1/2 + IFT-P 10 PCS</b> Spare filter for control panel ILS-1, ILS-2 and IFT-P. Pack of 10 units.
	<b>ISP-002</b>	<b>REPLACEMENT FILTER ELEMENT, IFT-P STAGE 2, 10 PCS</b> Spare filter for control panel IFT-P, second stage. Pack of 10 units.
	<b>059-001</b>	<b>FLUSH SAMPLE POINT KIT AND 2M PIPE</b> Flush sample point kit and 2 metre length of 10 mm pipe (1 piece).
	<b>059-007</b>	<b>CONICAL SAMPLE POINT KIT AND 2M TUBE</b> Conical sample point kit and 2 metre length of 10 mm pipe (1 piece).
	<b>128-014</b>	<b>ROUND SAMPLING POINT LABEL (100 PCS)</b> Round sampling point label (100 pieces on roll).
	<b>128-015</b>	<b>SMOKE DETECTOR PIPE LABEL (100 PCS)</b> Smoke detector pipe label (100 pieces).





**128-046**

**ROUND SAMPLING POINT LABEL (100 PCS)**  
Rectangular sampling point label (200 pieces on roll).



**144-013**

**CONICAL SAMPLE POINT HEAD**  
Conical sample point head



**221-035**

**RED 10MM CAPILLARY PIPE (100M)**  
RAL3000 10mm capillary pipe (100m reel)



**221-036**

**CLEAR 10MM CAPILLARY PIPE (100M)**  
Clear 10mm capillary tube (100m reel)



**222-059**

**DISCREET END CAP FOR CAPILLARY PIPE (10 PCS)**  
End cap for capillary pipe (10 pieces)

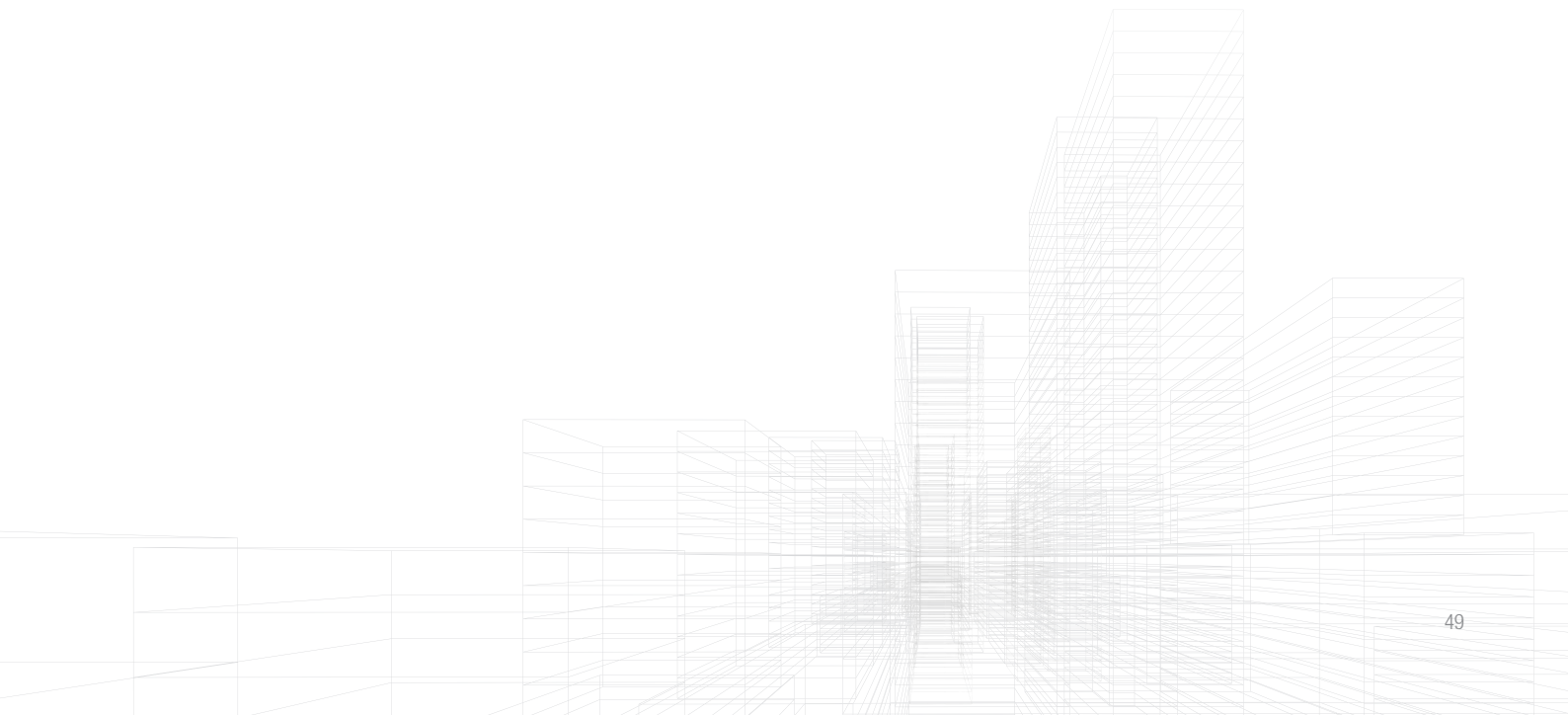



# THE BEAM DETECTION RANGE

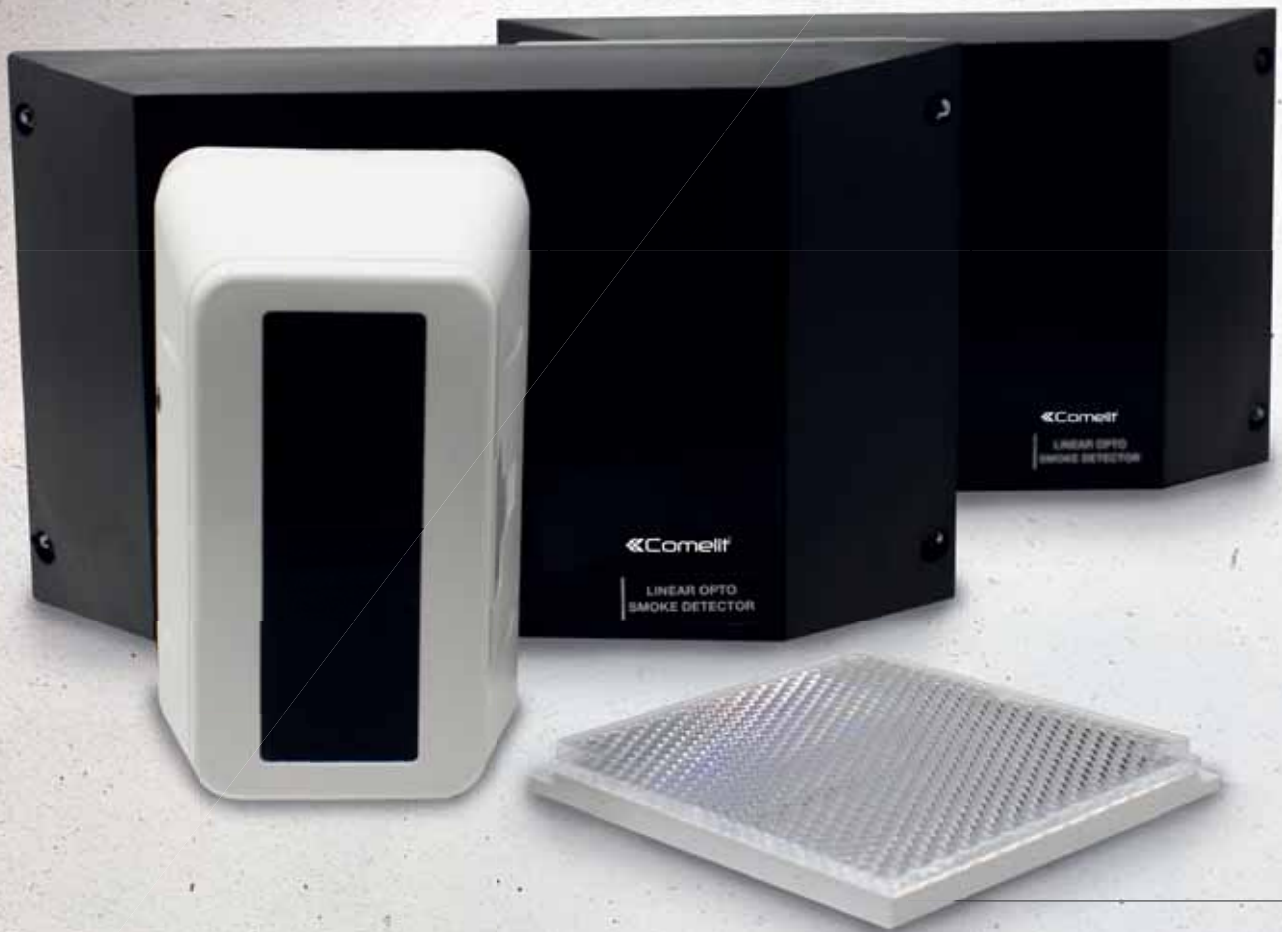

## BEAM DETECTORS PROTECTING LARGE SPACES

Wherever the size of the areas that need protecting makes the installation of point technology difficult, beam detectors are the most suitable and effective solution. The various technologies used (reflection or transceiver) provide a solution that is suited to all application types, with a significantly lower installation cost. They can be made to communicate with conventional or addressable systems; calibration and alignment are quick and easy to perform. Ranges vary from a minimum of 5 m up to 200 m.

### APPLICATIONS



### ADVANTAGES



EN54-12



BEAM  
DETECTORS



BEAM  
DETECTORS



RANGE



LASER  
POINTER



## BEAM DETECTORS RANGE DEVICES



### 48BFC000



EN54-12



RANGE



BEAM  
DETECTORS



LASER  
POINTER

### SMOKE BEAM DETECTOR 3 30 M

48BFC000 is an optical beam detector which provides protection over distances ranging from 3 m to 30 m and up to 15 m wide. Equipped with an integral laser and a set of passive reflectors, it is ideal for use in areas where the installation of standard point smoke detectors would be too problematic or impossible. The integral laser allows simple auto-alignment without the need for any special instruments or equipment. Also equipped with two changeover relay contacts for alarm and fault signalling. **Approved to EN 54-12.**



### 48BFA003

### FLUSH MOUNTING BOX FOR 48BFC000

Accessory for flush mounting of barrier 48BFC000



### 48BFC002



EN54-12



RANGE



BEAM  
DETECTORS



LASER  
POINTER



BIM

### SMOKE BEAM DETECTOR 5-50 M

48BFC002 is a beam detector, ideal for protecting the large areas found in industrial or commercial sites, or even long corridors, large halls or rooms with similar characteristics. The technology used offers a coverage area of between 5 and 50 metres. It is especially suitable for protecting very tall buildings as an alternative to point detectors, for aesthetic reasons or to limit the number of detectors in the space. Signals variations in status via relays and requires external power supply. **Approved to EN 54-12.**



### 48BFA004

### SPARE REFLECTOR FOR 48BFC002

Spare reflector for beam detector 48BFC002.



### 48BFC003

### SMOKE BEAM DETECTOR 50-100 M

Beam detector, ideal for protecting the large areas found in industrial or commercial sites, or even long corridors, large halls or rooms with similar characteristics. 48BFC003 works with a dedicated reflector; the technology used offers a coverage area of between 50 and 100 metres. It is especially suitable for protecting very tall buildings as an alternative to point detectors, for aesthetic reasons or to limit the number of detectors in the space. Signals variations in status via relays and requires external power supply. **Approved to EN 54-12.**



EN54-12



RANGE



BEAM  
DETECTORS



LASER  
POINTER



### 48BFA006

### SPARE REFLECTOR FOR 48BFC003

Spare reflector for beam detector 48BFC003.



### RK100-B

### SMOKE/HEAT BEAM DETECTOR 120 M TX+RX

The RK100-B detector is a linear optical smoke detector with barrier (separate TX and RX), with a maximum optical range of 120 m (minimum useful distance 25 m). It has 2 independent smoke detection circuits: Clouding and Turbulence - and is capable of detecting white or black smoke, fumes or mists. A single detector can cover an area of up to 1600 sq. m (standards EN54-14 and UNI 9795 ed. 2005) and is the ideal solution for installation in supermarkets, industrial storage facilities, warehouses, theatres/cinemas, shops, hotels, control rooms and, in situations where the optical window for passage of the infrared beam between Transmitter and Receiver is very small (goods storage warehouses with a lot of shelving), an opening of around 10 cm is enough to guarantee the correct beam intensity. Equipped with 2 Alarm relays and 1 fault relay, 0-5 V analogue output for viewing the signal level at a distance and automatic drift compensation circuit. Integrated laser module for quick and precise optical alignment, even at greater distances. Simple installation and easy infrequent maintenance. Power supply 11/30 Vdc. Built-in LED for status indication. IP65 protection rating with polycarbonate housing. **VDS and CPR certified in accordance with standard EN54-12.**



EN54-12



RANGE



TX+RX  
BEAM  
DETECTORS



LASER  
POINTER



### RK100-BS



### SMOKE BEAM DETECTOR 120 M TX+RX

The RK100-BS is a beam smoke detector with barrier (separate TX and RX), with a maximum optical range of 120 m (minimum useful distance 25 m). Capable of detecting white or black smoke, fumes or mists. A single detector can cover an area of up to 1600 sq. m (standards EN54-14 and UNI 9795 ed. 2005) and is the ideal solution for installation in supermarkets, industrial storage facilities, warehouses, theatres/cinemas, shops, hotels, control rooms and, in situations where the optical window for passage of the infrared beam between Transmitter and Receiver is very small (goods storage warehouses with a lot of shelving), an opening of around 10 cm is enough to guarantee the correct beam intensity. Equipped with 1 Alarm relay and 1 fault relay, 0-5 V analogue output for viewing the signal level at a distance and automatic drift compensation circuit. Integrated laser module for quick and precise optical alignment, even at greater distances. Simple installation and easy infrequent maintenance. Power supply 11/30 Vdc. Built-in LED for status indication. IP65 protection rating with polycarbonate housing. VDS and CPR certified in accordance with standard EN54-12.



### RK200-B



### SMOKE/HEAT BEAM DETECTOR 200 M TX+RX

The RK200-B detector is a linear optical smoke detector with barrier (separate TX and RX), with a maximum optical range of 200 m (minimum useful distance 40 m). It has 2 independent smoke detection circuits: Clouding and Turbulence - and is capable of detecting white or black smoke, fumes or mists. A single detector can cover an area of up to 1600 sq. m (standards EN54-14 and UNI 9795 ed. 2005) and is the ideal solution for installation in supermarkets, industrial storage facilities, warehouses, theatres/cinemas, shops, hotels, control rooms and, in situations where the optical window for passage of the infrared beam between Transmitter and Receiver is very small (goods storage warehouses with a lot of shelving), an opening of around 10 cm is enough to guarantee the correct beam intensity. Equipped with 2 Alarm relays and 1 fault relay, 0-5 V analogue output for viewing the signal level at a distance and automatic drift compensation circuit. Integrated laser module for quick and precise optical alignment, even at greater distances. Simple installation and easy infrequent maintenance. Power supply 11/30 Vdc. Built-in LED for status indication. IP65 protection rating with polycarbonate housing. VDS and CPR certified in accordance with standard EN54-12.



### RK200-BS



### SMOKE BEAM DETECTOR 200 M TX+RX

The RK200-BS detector is a linear optical smoke detector with barrier (separate TX and RX), with a maximum optical range of 200 m (minimum useful distance 40 m). Capable of detecting white or black smoke, fumes or mists. A single detector can cover an area of up to 1600 sq. m (standards EN54-14 and UNI 9795 ed. 2005) and is the ideal solution for installation in supermarkets, industrial storage facilities, warehouses, theatres/cinemas, shops, hotels, control rooms and, in situations where the optical window for passage of the infrared beam between Transmitter and Receiver is very small (goods storage warehouses with a lot of shelving), an opening of around 10 cm is enough to guarantee the correct beam intensity. Equipped with 1 Alarm relays and 1 fault relay, 0-5 V analogue output for viewing the signal level at a distance and automatic drift compensation circuit. Integrated laser module for quick and precise optical alignment, even at greater distances. Simple installation and easy infrequent maintenance. Power supply 11/30 Vdc. Built-in LED for status indication. IP65 protection rating with polycarbonate housing. VDS and CPR certified in accordance with standard EN54-12.



### RK100-BS-EX



### SMOKE BEAM DETECTOR 120 M TX+RX, ATEX

The RK100-BS-EX detector is a linear optical smoke detector with barrier (separate TX and RX). It is designed to detect fires in hazardous environments, where regulations require the system to be in an explosion protection application. It is used in areas at risk of explosion or fire, in compliance with CEI 31-33 CEI 31-35 installation standards. More specifically, in hazardous areas classed as zones 1-2-21-22. The RK100-BS-EX has a maximum optical range of 120 m and features a built-in laser pointer for accurate and rapid aim between transmitter and receiver. Operation is based on the interaction between the smoke in the room, generated by the start of a fire and an infrared beam emitted by the transmitter to the receiver. This detector is also capable of detecting smoke, vapours and mists. ATEX CESA 036 approved. VDS and CPR certified in accordance with standard EN54-12.



# THE GAS DETECTION RANGE



 Comelit®



## GAS DETECTION WHEN YOU CAN'T SEE THE DANGER

Gas detection is utilised in areas where precise and punctual readings of the percentage of a specific gas in the room are required. Possible solutions include detection in garages, boiler rooms, laboratories, depots and storage sites, with many types (electrochemical-catalytic) linked to the environment in which they are installed.

### APPLICATIONS



### ADVANTAGES



GAS

4-20  
mA

SEN-  
SORS



EX



## GAS DETECTION CONTROL PANELS

47CPG424

WALL-MOUNTED GAS CONTROL PANEL 4 - 24 SENSORS



The wall-mounted gas control panel 47CPG424 can manage up to 4, 8, 16 or 24 remote gas detectors. Thanks to the backlit colour (RGB) graphic display located on the front of the control panel, the user can view in real-time the values of all the gas detectors connected to the panel. Equipped with 4 inputs and 5 relay outputs, which can be increased to 24 detector inputs and 9 relays by the addition of the specific expansion cards. Supply voltage: 230Vac.

4-20  
mA

SENSORS

4-IN

MODULES

5-OUT

MODULES

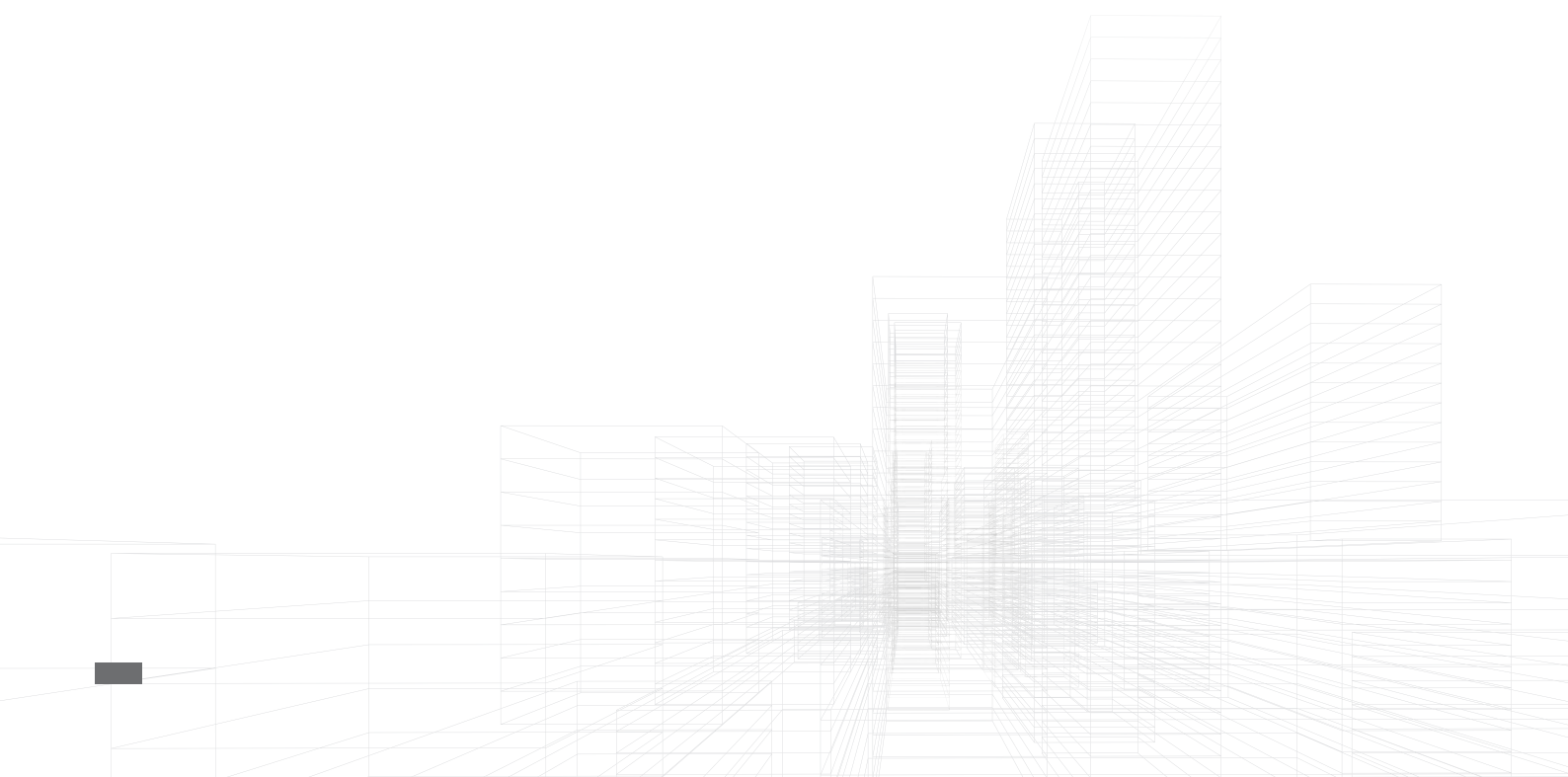



## 47CPG408

## WALL-MOUNTED GAS CONTROL PANEL 4 - 8 SENSORS



The wall-mounted gas control panel 47CPG408 can manage up to 4 or 8 remote gas detectors. Thanks to the backlit graphic display located on the front of the control panel, the user can view in real-time the values of all the gas detectors connected to the panel. Equipped with 2 inputs and 5 relay outputs, which can be increased to 8 detector inputs and 9 relays by the addition of the specific expansion cards. Supply voltage: 230Vac.

4-20  
mA  
SENSORS

4-IN  
MODULES

5-OUT  
MODULES



## ACCESSORIES



### 47ESP040

4-20  
mA  
SENSORS

4-IN  
MODULES

### 4 INPUT EXPANSION FOR GAS CONTROL PANEL 47CPG424

Expansion card with 4 inputs for 4-20mA sensors; can be connected to control panel 47CPG408 (max. 1 expansion) and to control panel 47CPG424 (max. 1 expansion).



### 47REL040

4-OUT  
MODULES

### 4 RELAY EXPANSION FOR GAS CONTROL PANELS

Expansion card with 4 relay outputs; can be connected to control panel 47CPG408 (max. 1 expansion) and to control panel 47CPG424 (max. 1 expansion).



### 47ESP080

4-20  
mA  
SENSORS

8-IN  
MODULES

### 8 INPUTS EXPANSION FOR GAS CONTROL PANEL 47CPG424

Remote unit with 8 inputs for 4-20mA sensors; can be connected only to control panel 47CPG424 via RS485 port (max. 2 units).



### 47SER080

4-OUT  
MODULES

### BOARD W/4 RELAY OUTPUTS FOR 47ESP080 (MAX. 2)

Additional expansion board with 4 relay outputs, for connection to remote unit 47ESP080 (max. 2 expansions per unit).



## GAS CONTROL PANELS AND DETECTORS



### 47CDG206

4-20  
mA

SENSORS

2-IN

MODULES

### GAS CONTROL PANEL ON DIN RAIL 2 - 6 SENSORS

Control panel 47CDG206 for DIN rail mounting is used in centralised alarm systems for car parks, factories and environments requiring protection against possible leaks of inflammable or toxic gas and oxygen. Two 4-20 mA remote sensors can be connected to the control panel and a maximum of 6 sensors can be connected with the use of two 47EDG020 expansion units. Dimensions: 4 DIN modules. Supply voltage: 12-24 VDC.



### 47EDG020

4-20  
mA

SENSORS

2-IN

MODULES

### 2 SENSORS EXPANSION FOR 47CDG206

Expansion module for two sensors. Two 47EDG020 modules can be added to the 47CDG206 control panel for the connection of a maximum of 6 sensors. Connection to the control panel: 4 wire Dimensions: 2 DIN modules.



### 47ADG206

### DIN RAIL POWER SUPPLY UNIT FOR CONTROL PANEL 47CDG206

230Vac/24Vdc power supply unit. Capable of powering both the control panel 47CDG206 and additional modules 47EDG020 and the sensors connected to them. Dimensions: 3 DIN modules.



### 47BDL012

### LITHIUM BATTERY ON DIN RAIL

Lithium battery for control panel 47CDG206 that allows 30/40 minutes of autonomous operation for a fully configured system. It can be installed on DIN rails with obvious advantages in terms of space-saving and cost. Dimensions: 3 DIN modules. Output voltage: 10.8 VDC. Capacity: 1.7 Ah.



### 47ADB012

### POWER SUPPLY UNIT FOR 12V LITHIUM BATTERY

230Vac power supply unit, with 12Vdc output. Can be used to recharge lithium batteries 47BDL012. Dimensions: 3 DIN modules.



**47CMZ001**





4-20  
mA

SENSORS



1-IN

MODULES



RELAYS



IP 65

PROTECTION RATING

**SINGLE-ZONE WALL-MOUNTED GAS CONTROL PANEL**

47CMZ001 is a wall-mountable control panel suitable for use with central heating systems, for connection of a remote catalytic detector for inflammable gas: 47SE192KM for methane and 47SE192KG for LPG. The control panel can be powered by mains voltage (230Vac) or by 12Vdc/Vac. IP65 protection rating.

**47CPZ003**





4-20  
mA

SENSORS



3-IN

MODULES



RELAYS



IP 65

PROTECTION RATING

**WALL-MOUNTED GAS CONTROL PANEL 3 DETECTORS**

47CPZ003 is a wall-mountable control panel suitable for use with central heating systems, for connection of a remote catalytic detector for inflammable gas: 47SE192KM for methane and 47SE192KG for LPG. The control panel can be powered by mains voltage (230Vac) and/or by 12Vdc/Vac. IP65 protection rating.

**47SE192KM**





GAS



4-20  
mA

SENSORS



IP 44

PROTECTION RATING

**METHANE GAS DETECTOR**

Catalytic sensor for methane gas. For connection exclusively to control panels 47CMZ001/47CPZ003. Completely insensitive to temperatures and humidity, with professional sensing element, Ideal for installation in central heating systems or small/medium businesses to detect possible gas leaks. Powered directly from control panels 47CMZ001/47CPZ003. 12Vdc power supply, 1W power consumption: 4-20mA outputs, 0-20% LEL detection range, IP44 protection rating. Service life approx. 5 years.

**47SE192KG**





GAS



4-20  
mA

SENSORS



IP 44

PROTECTION RATING

**LPG GAS DETECTOR**

Catalytic sensor for LPG. For connection exclusively to control panels 47CMZ001/47CPZ003. Completely insensitive to temperatures and humidity, with professional sensing element, Ideal for installation in central heating systems or small/medium businesses to detect possible gas leaks. Powered directly from control panels 47CMZ001/47CPZ003. 12Vdc power supply, 1W power consumption: 4-20mA outputs, 0-20% LEL detection range, IP44 protection rating. Service life approx. 5 years.



## ACCESSORIES



### 47TS255CB



GAS



SENSORS



MODULES



PROTECTION RATING

### INDUSTRIAL DUAL GAS DETECTOR 4-20MA

Gas detector 47TS255CB has two 4-20mA outputs for Carbon Monoxide (CO) and petrol fumes. It is equipped with two sensors and replaceable cartridges. The detector is ideal for installation in underground car parks or anywhere it is necessary to detect gases of different types. It occupies 2 physical inputs on the control panel.



### 47RTS282KM



GAS



SENSORS



RELAYS



PROTECTION RATING

### AUTONOMOUS INDUSTRIAL GAS DETECTOR METHANE

Autonomous detector with catalytic sensor for the detection of Methane (CH<sub>4</sub>), equipped with 3 alarm relays and one fault relay. 4-20mA output signal and replaceable sensor cartridge. Power supply: 12-24Vdc. Protection rating: IP65.



### 47RTS282KG



GAS



SENSORS



RELAYS



PROTECTION RATING

### AUTONOMOUS INDUSTRIAL GAS DETECTOR LPG

Autonomous detector with catalytic sensor for the detection of LPG (Liquid Petroleum gas), equipped with 3 alarm relays and one fault relay. 4-20mA output signal and replaceable sensor cartridge. Power supply: 12-24Vdc. Protection rating: IP65.



### 47RTS282KI



GAS



SENSORS



RELAYS



PROTECTION RATING

### AUTONOMOUS INDUSTRIAL GAS DETECTOR HYDROGEN

Autonomous detector with catalytic sensor for the detection of Hydrogen (H<sub>2</sub>), equipped with 3 alarm relays and one fault relay. 4-20mA output signal and replaceable sensor cartridge. Power supply: 12-24Vdc. Protection rating: IP65.



### 47RTS282KB



GAS



SENSORS



RELAYS



PROTECTION RATING

### AUTONOMOUS INDUSTRIAL GAS DETECTOR PETROL VAPOUR

Autonomous detector with electrochemical sensor for the detection of petrol fumes (unleaded petrol), equipped with 3 alarm relays and one fault relay. 4-20mA output signal and replaceable sensor cartridge. Power supply: 12-24Vdc. Protection rating: IP65.



### 47RTS282EO



GAS



SENSORS



RELAYS



PROTECTION RATING

### AUTONOMOUS INDUSTRIAL GAS DETECTOR OXYGEN

Autonomous detector with electrochemical sensor to detect the absence or an excess of oxygen (O<sub>2</sub>) or inert gas. Equipped with 3 alarm relays and one fault relay. 4-20mA output signal and replaceable sensor cartridge. Power supply: 12-24Vdc. Protection rating: IP65.



### 47RTS282EC-S



GAS



SENSORS



RELAYS



PROTECTION RATING

### AUTONOMOUS INDUSTRIAL GAS DETECTOR CO

Autonomous detector with electrochemical sensor for the detection of Carbon Monoxide (CO), equipped with 3 alarm relays and one fault relay. 4-20mA output signal and replaceable sensor cartridge. Power supply: 12-24Vdc. Protection rating: IP65.



**47ZSK01/IP**

**AUTONOMOUS INDUSTRIAL GAS CARTRIDGE METHANE + LPG**

Replacement cartridge for methane of LPG detector.



**47ZSK02/IP**

**AUTONOMOUS INDUSTRIAL GAS CARTRIDGE HYDROGEN**

Replacement cartridge for Hydrogen detector.



**47ZSKB/IP**

**AUTONOMOUS INDUSTRIAL GAS CARTRIDGE FOR PETROL VAPOURS**

Replacement cartridge for petrol fumes detector.



**47ZSEC/IP**

**AUTONOMOUS INDUSTRIAL GAS CARTRIDGE CO**

Replacement cartridge for Carbon Monoxide detector.



**47ZSE0/IP**

**AUTONOMOUS INDUSTRIAL GAS CARTRIDGE OXYGEN**

Replacement cartridge for Oxygen detector.



**47ZSEC1**

**GAS CARTRIDGE FOR CO DETECTOR 47TS255CB**

Replacement cartridge for Carbon Monoxide detector art. 47TS255CB.



**47ZSK04**

**CARTRIDGE FOR PETROL FUMES DETECTOR 47TS255CB**

Replacement cartridge for petrol fumes detector art. 47TS255CB.



**47RFM000**

**METHANE GAS DETECTOR FOR DOMESTIC USE**

This methane leak detector for domestic use, alerts the user via a visual signal (3 LEDs) and an audible signal (internal buzzer) to the presence of gas in the environment. It is designed to function as a gas detector with a voltage-free relay output. Contact ratings 8A-250Vac/30Vdc. The detector is calibrated to detect a concentration of gas equivalent to 10% of the LEL (Lower Explosive Limit). This value may vary according to the environmental conditions but will not exceed 15% of the LEL during the first 4 years of operation.



GAS



RELAYS



**47RFG000**

**LPG DETECTOR FOR DOMESTIC USE**

This LPG leak detector for domestic use, alerts the user via a visual signal (3 LEDs) and an audible signal (internal buzzer) to the presence of gas in the environment. It is designed to function as a gas detector with a voltage-free relay output. Contact ratings: 8A-250Vac/30Vdc. The detector is calibrated to detect a concentration of gas equivalent to 10% of the LEL (Lower Explosive Limit). This value may vary according to the environmental conditions but will not exceed 15% of the LEL during the first 4 years of operation.



GAS



RELAYS

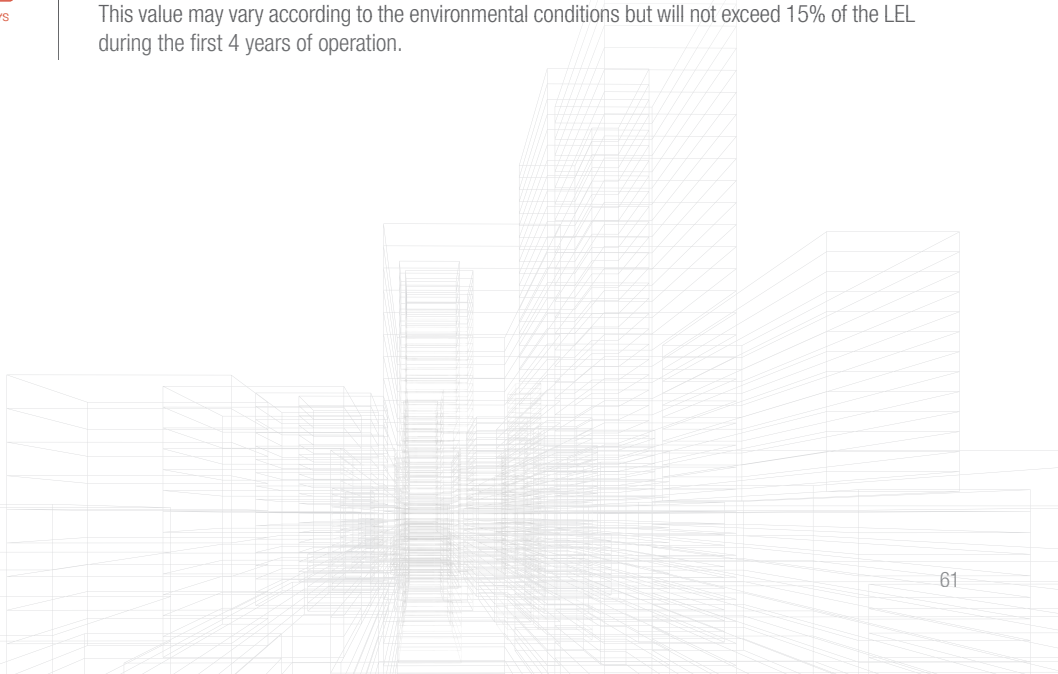



# THE ATEX RANGE



 Comelit®



## ATEX HIGH RISK OF EXPLOSION

The ATEX acronym identifies an environment with a high explosion risk. The devices used in these environments must have ultra-low operating voltage and avoid creating potential sparks which could start a fire or cause an explosion.

### APPLICATIONS



### ADVANTAGES





## ATEX RANGE DEVICES



### 48BAZ000



#### ZENER BARRIER FOR ATEX DETECTORS

Zener barrier certified as an intrinsically safe electrical system. Specifically designed for use with our detector 48RCX000, 48RFX000 and manual call button 48PAX000. Voltage: 24Vdc Dimensions: 104 x 70 x 12.2 mm. Certified to CE 0081 II (1/2) G [Eex ia/ib] IIC/IIB/PTB 01 ATEX 2088 standards.



### 48BAZ001



#### ZENER BARRIER FOR ATEX SOUNDER

Zener barrier certified as an intrinsically safe electrical system. Specifically designed for use with our siren 48SAX000 Voltage: 15-28Vdc. Dimensions: 70 x 80 x 10 mm. Certified to CE 0359 II (1) GD [Eex ia] IIC/BAS 01 ATEX 7005 standards.



### 48RCX000



#### ATEX HEAT-RATE OF RISE DETECTOR

59°C temperature detector and 9°C/min rate-of-rise detector with 59°C static safety for zones with atmospheres with high risk of explosion. Voltage: 12-30Vdc Current consumption on stand-by: 120µA. Approved to CE 0081 II 1 G Eex ia IIC T6/LCIE 03 ATEX 6350 X.



### 48RFX000



#### ATEX WIRELESS OPTICAL SMOKE DETECTOR

Optical smoke detector with built-in safety and Tyndall effect operating principle. Designed for installation in premises with an explosive atmosphere (Zone 0, Zone 1, Zone 2). Pairs with barrier 48BAZ000. Approved and conforms to standards CE 0081 II 1 G Eex ia IIC T6/LCIE 03 ATEX 6350 X and approved to standard EN54-7.



### 48RBX000



#### MOUNTING BASE FOR ATEX DETECTORS

Mounting base for ATEX detectors 48RCX000, 48RFX000.



### 48PAX000



#### ATEX MANUAL CALL POINT

Manual call point for use in atmospheres with high risk of explosion. Activated mechanically by pressing on the front window. Includes an operating element that can be reset with the aid of special key. Operating voltage: 13 to 28Vdc Current consumption: 150 µA. Approved to EN 60079-0 (09), EN 60079-11 (07) and conforming to directives ATEX 94/9/EC.



### 48SAX000



#### ATEX SOUNDER

Sounder for use in areas with atmospheres with high risk of explosion to be used in conjunction the Zener barrier 48BAZ001. Operating voltage: 15-28Vdc. Approved to CE 0359 II 1 G Eex ia IIC T4/BAS 00 ATEX 1181.



# ATEX DIAGRAM

EXAMPLE OF ATEX CONNECTION TO AN ADDRESSABLE CONTROL PANEL

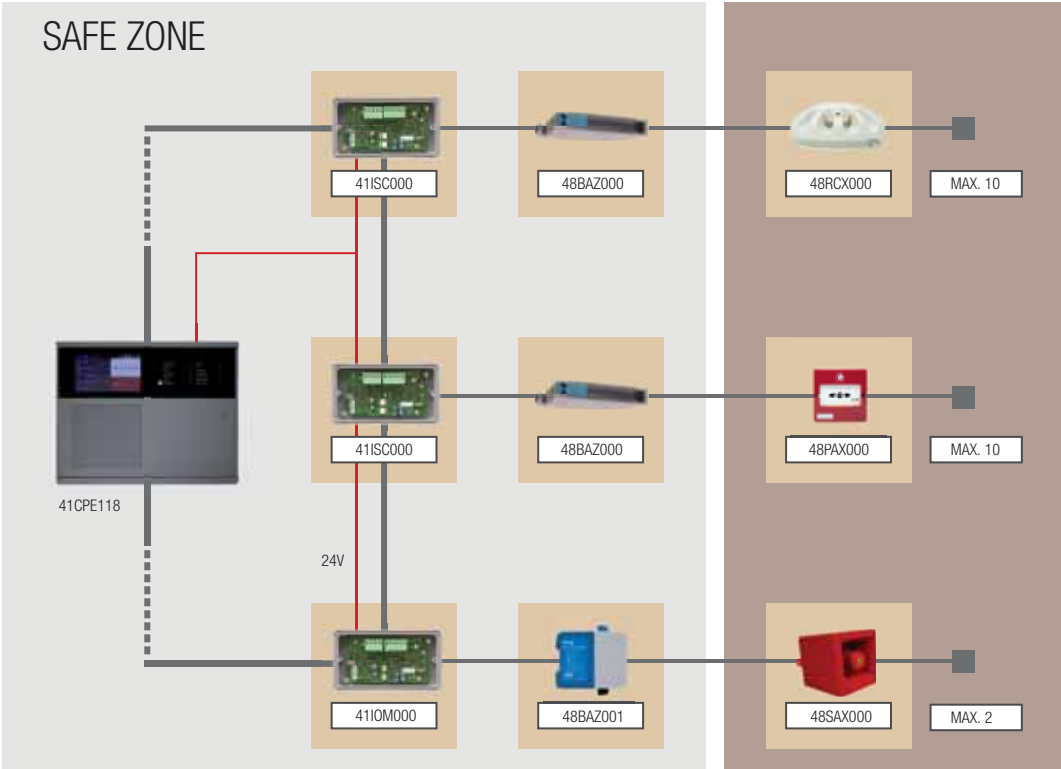

EXAMPLE OF ATEX CONNECTION TO A CONVENTIONAL CONTROL PANEL

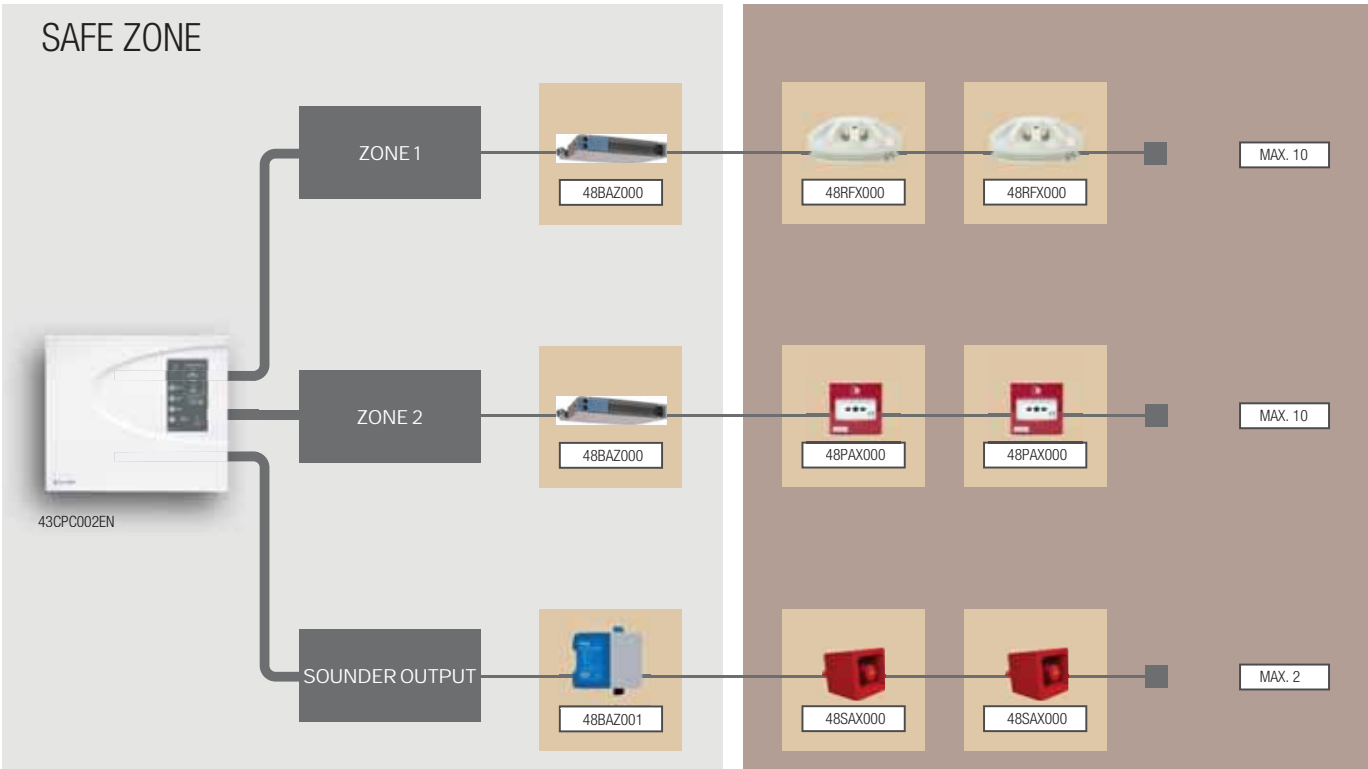



# THE RANGE OF COMMON ACCESSORIES



 Comelit®

## COMMON ACCESSORIES

An entire series of required devices supplied to complete the range. It includes additional power supply units, electromagnets, analysis chambers, cables and batteries.

### APPLICATIONS



### ADVANTAGES



EN54-4  
EN54-21  
EN30200



ELECTROMAGNETS ELECTROMAGNETS



## COMMON ACCESSORIES RANGE DEVICES



**ZSP100-  
2.5A-18**



EN54-4  
EN12101-10



**ZSP100-  
5.5A-18**



EN54-4  
EN12101-10



**CT440EN**



EN54-21



**CT400EN**



EN54-21



**48CAC001**



**48FME051**



EN54-21 ELECTROMAGNETS



**48FME052**



EN155 ELECTROMAGNETS

### 2.5A ADDITIONAL POWER SUPPLY UNIT

" Power supply unit designed to provide auxiliary power supply. Metal casing with IP44 protection degree. Total available current 2.5A. Maximum recommended capacity for battery housing (with series connection) 2 x 12V / 18Ah. 230VAC power supply voltage. Rated output voltage 27.5VDC (with batteries not connected). Dimensions (WxHxD) 395 x 356 x 96mm. The power supply is equipped with 2 outputs with potential-free relays for the signals required by the EN54-4 standard. Certification according to EN 54-4, EN12101-10."

### 5.5A ADDITIONAL POWER SUPPLY UNIT

" Power supply unit designed to provide auxiliary power supply. Metal casing with IP44 protection degree. Total available current 5.5A. Maximum recommended capacity for battery housing (with series connection) 2 x 12V / 18Ah. 230VAC power supply voltage. Rated output voltage 27.5VDC (with batteries not connected). Dimensions (WxHxD) 395 x 356 x 96mm. The power supply is equipped with 2 outputs with potential-free relays for the signals required by the EN54-4 standard. Certification according to EN 54-4, EN12101-10."

### TELEPHONE DIALLER PSTN GSM 3G IP EN54-21

IP, GSM, 3G / 4G telephone dialler. EN54-21 certified. Equipped with a touch screen for configuring settings, easy configuration through Wizard programming. It has 4 monitored inputs including 2 dedicated to alarm and fire failure signals when the dialler is in EN54-21 mode and 4 on-board relays (100mA @ 24VDC), housed in a plastic box that allows for practical assembly . Power supply 9-28VDC, absorption 151mA. N.B. The institute / alarm receiving center must be certified according to the regulations in force.

### TELEPHONE DIALLER PSTN GSM 3G EN54-21

GSM, 3G / 4G telephone dialler. EN54-21 certified. Equipped with a touch screen for configuring settings, easy configuration through Wizard programming. It has 4 monitored inputs including 2 dedicated to alarm and fire failure signals when the dialler is in EN54-21 mode and 4 on-board relays (100mA @ 24VDC), housed in a plastic box that allows for practical assembly . Power supply 9-28VDC, absorption 151mA. N.B. The institute / alarm receiving center must be certified according to the regulations in force.

### DUCT DETECTOR

Test chamber designed to house an analogue or conventional detector for the testing of ventilation ducts; uses the Pitot tube principle to continuously sample air circulating through the duct and analyse it using the smoke detector housed in the chamber. Positioned inside the duct, the test chamber has an air inlet pipe and an outlet pipe; inside the test chamber the detector analyses the sampled air. To be used in conjunction with a base and an analogue or conventional smoke detector.

### 50 KG MAGNETIC DOOR HOLDER

Electromagnet with 50 kg holding force for fire doors. Can be wall or floor mounted, with optional backplate (art. 48FMA03). Automatic release in the event of fire. Manual release button included. Connection terminals, equipped with diode for protection against inverse polarity and current limiting resistor. Quick-fix keeper plate. Nickel-plated steel body for maximum corrosion resistance. Fibreglass-reinforced thermoplastic base. Power supply 24 Vdc. Absorption 50 mA. Low current consumption mode. Approved to EN 1155.

### MAGNETIC DOOR HOLDER 50 KG WITH 15CM BACKPLATE

Electromagnet with 50 kg holding force for fire doors. Can be wall or floor mounted. Automatic release in the event of fire. Manual release button included. Connection terminals, equipped with diode for protection against inverse polarity and current limiting resistor. Quick-fix keeper plate. Nickel-plated steel body for maximum corrosion resistance. Fibreglass-reinforced thermoplastic base. Power supply 24 Vdc. Absorption 50 mA. Low current consumption mode. 15 cm wall or floor backplate. Approved to EN 1155.



**48FME053**



EN54-21 ELECTROMAGNETS

**MAGNETIC DOOR HOLDER 50 KG WITH 30CM BACKPLATE**

Electromagnet with 50 kg holding force for fire doors. Can be wall or floor mounted. Automatic release in the event of fire. Manual release button included. Connection terminals, equipped with diode for protection against inverse polarity and current limiting resistor. Quick-fix keeper plate. Nickel-plated steel body for maximum corrosion resistance. Fibreglass-reinforced thermoplastic base. Power supply 24 Vdc. Absorption 50 mA. Low current consumption mode. 30 cm wall or floor backplate. Approved to EN 1155.



**48FME101**



EN54-21 ELECTROMAGNETS

**100 KG MAGNETIC DOOR HOLDER**

Electromagnet with 100 kg holding force for fire doors. Can be wall or floor mounted, with optional backplate (art. 48FMA03). Automatic release in the event of fire. Manual release button included. Connection terminals, equipped with diode for protection against inverse polarity and current limiting resistor. Quick-fix keeper plate. Nickel-plated steel body for maximum corrosion resistance. Fibreglass-reinforced thermoplastic base. Power supply 24 Vdc. Absorption 100 mA. Low current consumption mode. Approved to EN 1155.



**48FMA01**

**ALUMINIUM COVER FOR 48FME051**

Aluminium cover for electromagnetic door stop 48FME051



**48FMA02**

**ALUMINIUM COVER FOR 48FME101**

Aluminium cover for electromagnetic door stop 48FME101



**48FMA03**

**FLOOR-STANDING BACKPLATE FOR 48FME051 AND 48FME101**

Aluminium backplate for floor mounting of electromagnetic door stops 48FME051 and 48FME101.



## COMMON ACCESSORIES RANGE DEVICES



### 48CTR068

#### LINEAR HEAT DETECTION CABLE, NON RESETTABLE, 68°C

Linear thermal cable, not resettable 68°C; at the nominal temperature the insulation melts, causing a short circuit between the 2 wires and generating an alarm signal.



### 48CTR105

#### LINEAR HEAT DETECTION CABLE, NON RESETTABLE, 105°C

Linear thermal cable, not resettable 105°C; at the nominal temperature the insulation melts, causing a short circuit between the 2 wires and generating an alarm signal.



### 48CVI115

#### FIRE CABLE EN50575 PH120 2x1.5 100M

PH120 red fire-resistant cable for fire protection systems, length 100 m, cross-section 2 x 1.5 mm<sup>2</sup>. **Approved to EN 50575:2016.**



EN50200  
EN50575:2016

CEI  
20-105

PH  
120



### 48CVI125

#### FIRE CABLE EN50575 PH120 2x2.5 100M

PH120 red fire-resistant cable for fire protection systems, length 100 m, cross-section 2 x 2.5 mm<sup>2</sup>. **Approved to EN 50575:2016.**



EN50200  
EN50575:2016

CEI  
20-105

PH  
120



### 48CVI515

#### FIRE CABLE EN50575 PH120 2x1.5 500M

Fire-resistant cable for fire detection and alarm systems, length 500 m, cross-section 2x1.5mm<sup>2</sup>. **Approved to EN 50575:2016.**



EN50200  
EN50575:2016

CEI  
20-105

PH  
120



### 48CVI525

#### FIRE CABLE EN50575 PH120 2x2.5 500M

Fire-resistant cable for fire protection systems, length 100 m, cross-section 2x2.5mm<sup>2</sup>. **Approved to EN 50575:2016.**



EN50200  
EN50575:2016

CEI  
20-105

PH  
120



### 48CVE115

#### EVAC CABLE EN50575 PH120 2x1.5 100M

Purple cable for vocal evacuation control panels, length 100 m, with cross-section 2 x 1.5 mm<sup>2</sup>. **Approved to EN 50575:2016.**



EN50200  
EN50575:2016

CEI  
20-105

PH  
120



### 48CVE125

#### EVAC CABLE EN50575 PH120 2x2.5 100M

Purple cable for vocal evacuation control panels, length 100 m, with cross-section 2 x 2.5 mm<sup>2</sup>. **Approved to EN 50575:2016.**



EN50200  
EN50575:2016

CEI  
20-105

PH  
120



### 48SDT001

#### AEROSOL FOR SMOKE DETECTOR TESTING

Aerosol for smoke detector testing.



**30076003**

**12V DC / 7 AH LEAD BATTERY**

12Vdc / 7 Ah lead battery



**30076004**

**12V DC / 18 AH LEAD BATTERY**

12Vdc / 18 Ah lead battery



**30076005**

**12V DC / 26 AH LEAD BATTERY**

12Vdc / 26 Ah lead battery



**30076006**

**12V DC/ 40 AH LEAD ACID BATTERY**

Lead battery in AGM technology. 12 Vdc / 40Ah. Each battery cell is equipped with a one-way safety valve that guarantees the disposal of possible overpressures of internal gas. Dimensions: 197x165x170 mm



**30076012**

**LEAD BATTERY 12 VDC 65AH**

Lead battery, 12 VDC / 65 Ah.



**30076013**

**LEAD BATTERY 12 VDC 100AH**

Lead battery, 12 VDC / 100 Ah.

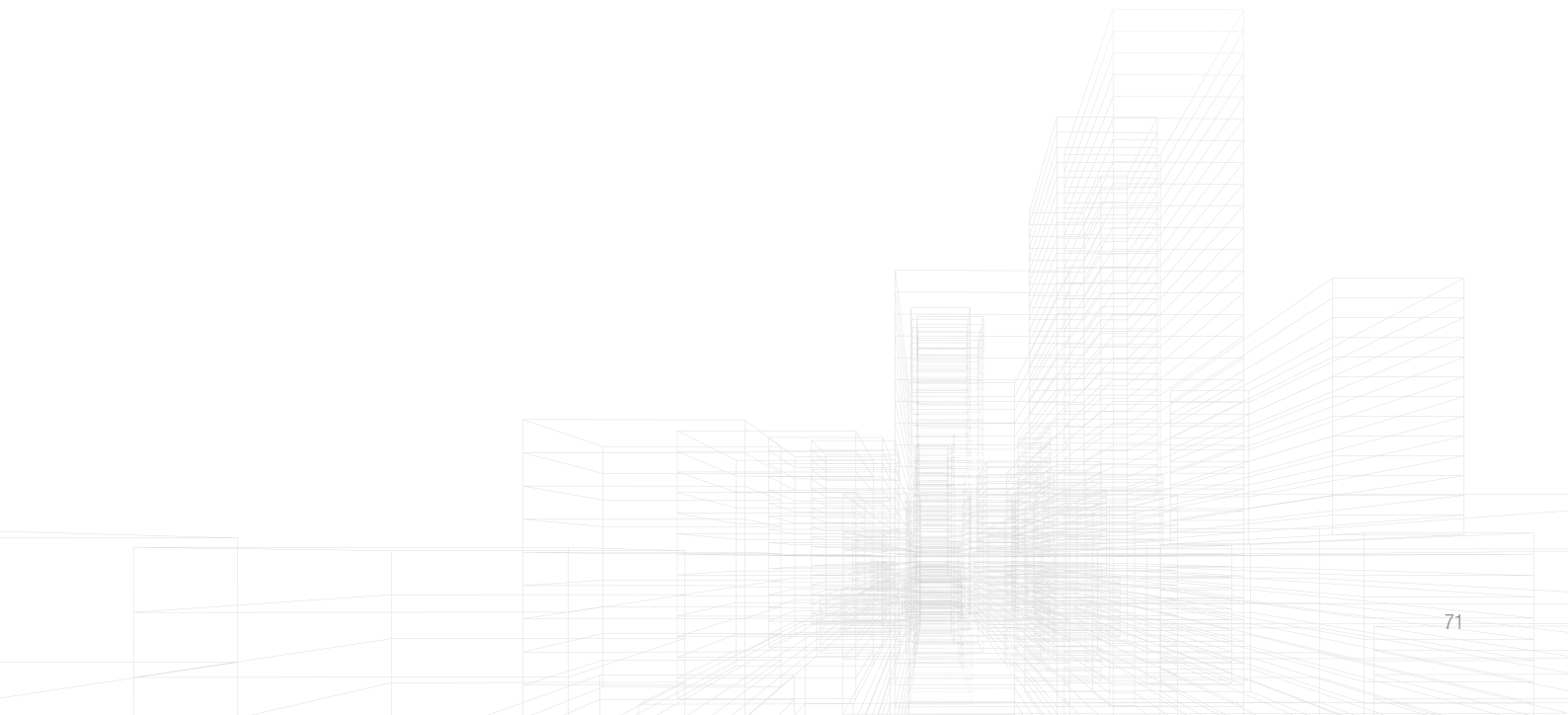



# THE EVAC RANGE





## EVAC SYSTEMS A VOICE TO GUIDE YOU

EVAC (Emergency Voice and Communication) systems perform a very important role when it comes to safety and the management of evacuation plans. A network of certified speakers alert people to any dangerous conditions present.

A clear and unencrypted voice message allows instant understanding of the emergency situation and the need to reach a safe place via the appropriate escape routes.

Integration with fire detection panels also means that all types of evacuation can be managed properly and in a structured manner, preventing crowds from forming and avoiding panic.

Emergency stations also allow security managers or the fire brigade to communicate “live” with all relevant zones, to provide important information regarding the events in progress.

### APPLICATIONS



### ADVANTAGES



EN54-4  
EN54-16  
EN54-24



6 NETWORK

500  
W

EVAC  
SYSTEMS

RS485

EVAC



## EVAC SYSTEMS

The full range of EVAC systems adapts perfectly to every installation environment in which a voice evacuation system is required, and is approved to EN54-16 and 54-4. The control panels can work in stand-alone mode or be connected in an RS485 network with up to 6 panels, for a total power of 3000 W.

One advantage is certainly the option of making the Evac systems communicate with all addressable fire detection panels (LOGIFIRE and ATENA) via RS485.

This makes it possible to manage all logics directly via the panel's cause-effect matrix, by individual zone, with various delays so as to ensure evacuation takes place correctly.

### 49CC0002

## COMPACT 2-ZONE EVAC CONTROL PANEL



Voice evacuation system 49CC0002 capable of managing 2 voice alarm zones with a maximum total power of 500W (this can be divided freely among the audio zones managed). Each zone is controlled by a specific amplifier with a maximum power of 250W. Option of interconnecting up to 6 control panels on the network. Handheld VVF microphone included for sending messages from the site. 7 supervised input contacts which can be configured for the playback of evacuation messages, alert and message reset, 1 audio input for external audio sources and 1 auxiliary input. Designed for easy installation and to occupy minimal space. Option of connecting up to 16 broadcast microphone stations art. 49PMS006 and 49PMS012, and 4 remote emergency stations art. 49BME001 and 49BME012. Dimensions: 430x620x240 mm.

**Approved to EN54-16, EN54-4.**



EN54-4  
EN54-16

2  
ZONES

2 ZONES

500  
W

EVAC  
SYSTEMS

7  
INPUTS

EVAC  
SYSTEMS

3  
OUTPUTS

EVAC  
SYSTEMS



PROTECTION  
RATING

RS485

EVAC



## 49CC0004

## COMPACT 4-ZONE EVAC CONTROL PANEL



Voice evacuation system 49CC0004 capable of managing 4 voice alarm zones with a maximum total power of 500W (this can be divided freely among the audio zones managed). Each zone is controlled by a specific amplifier with a maximum power of 250W. Option of interconnecting up to 6 control panels on the network. Handheld VVF microphone included for sending messages from the site. 7 supervised input contacts which can be configured for the playback of evacuation messages, alert and message reset, 1 audio input for external audio sources and 1 auxiliary input. Designed for easy installation and to occupy minimal space. Option of connecting up to 16 broadcast microphone stations art. 49PMS006 and 49PMS012, and 4 remote emergency stations art. 49BME001 and 49BME012. Dimensions: 430x620x240 mm.

**Approved to EN54-16, EN54-4.**



EN54-4  
EN54-16



4 ZONES



500 W  
EVAC SYSTEMS



7 INPUTS  
EVAC SYSTEMS



3 OUTPUTS  
EVAC SYSTEMS



PROTECTION RATING  
IP 30



RS485  
EVAC SYSTEMS



## 49CC0006

## COMPACT 6-ZONE EVAC CONTROL PANEL



Voice evacuation system 49CC0006 capable of managing 6 voice alarm zones with a maximum total power of 500W (this can be divided freely among the audio zones managed). Each zone is controlled by a specific amplifier with a maximum power of 250W. Option of interconnecting up to 6 control panels on the network. Handheld VVF microphone included for sending messages from the site. 7 supervised input contacts which can be configured for the playback of evacuation messages, alert and message reset, 1 audio input for external audio sources and 1 auxiliary input. Designed for easy installation and to occupy minimal space. Option of connecting up to 16 broadcast microphone stations art. 49PMS006 and 49PMS012, and 4 remote emergency stations art. 49BME001 and 49BME012. Dimensions: 430x620x240 mm.

**Approved to EN54-16, EN54-4.**



EN54-4  
EN54-16



6 ZONES



500 W  
EVAC SYSTEMS



7 INPUTS  
EVAC SYSTEMS



3 OUTPUTS  
EVAC SYSTEMS



PROTECTION RATING  
IP 30



RS485  
EVAC SYSTEMS





## ACCESSORIES



### 49BME216



EN54-16

#### EMERGENCY REMOTE TOUCH-SENSITIVE STATION

The touch screen emergency stations art. 49BME216 can be used to send hands-free messages and pre-recorded evacuation/pre-alarm messages. The large backlit display is used to manage and customise calls across all zones in the system, while corresponding LEDs provide the main information regarding the status of the emergency system and any faults which may have occurred. The station must be completed with an additional microphone (not included); choose between models 49MST002 or 49MPA003. Stations art. 49BME216 have 2 LEDs as standard, designed to indicate the operating status of the system. Stations art. 49BME216 must be connected to vocal evacuation control panels and used as an alternative to emergency stations art. 49BME001 and/or 49BME012. **Approved to EN 54-16.**



### 49BME001



EN54-16

#### REMOTE EMERGENCY CALL POINT

The remote station 49BME001 makes it possible, via a controlled microphone, to send live emergency messages or recorded alert and evacuation messages in a general call. The LEDs on the front panel provide the main information relating to emergency system status and faults. The station must be completed with an additional microphone (not included); either 49MST002 or 49MPA003. **Approved to EN 54-16.**



### 49BME012



EN54-16

#### 12-ZONE REMOTE EMERGENCY CALL STATION







The remote station 49BME012 makes it possible, via a controlled microphone, to send live emergency messages or recorded alert and evacuation messages in separate zones (max. 12). The LEDs on the front panel provide the main information relating to emergency system status and faults. The station must be completed with an additional microphone (not included); either 49MST002 or 49MPA003. **Approved to EN 54-16.**



### 49PMS006

#### MICROPHONE POINT WITH 6-ZONE MICROPHONE

Pre-amplified station with electret unit with flexible stem microphone. 6 keys for zone selection (can also be configured individually as alarm keys) and general call, release/hold PTT+LOCK button. Priority level configuration (up to level 7) and microphone sensitivity adjustment. Power on and busy indication light. RJ45 connectors for connection with direct CAT5 and SF-UTP cables.

	<b>49PMS012</b>	<p><b>MICROPHONE STATION WITH 12-ZONE MICROPHONE</b>          Pre-amplified station with electret unit with flexible stem microphone. 12 keys for zone selection (can also be configured individually as alarm keys) and general call, release/hold PTT+LOCK button. Priority level configuration (up to level 7) and microphone sensitivity adjustment. Power on and busy indication light. RJ45 connectors for connection with direct CAT5 and SF-UTP cables.</p>
	<b>49MPA003</b>	<p><b>HANDHELD MICROPHONE FOR REMOTE POINT</b>          Dynamic handheld microphone with PTT key for remote stations for emergency calls, 49BME001 and 49BME012. <b>Approved to EN 54-16.</b></p>
		
	<b>49MST002</b>	<p><b>STALK-MOUNTED MICROPHONE FOR REMOTE POINT</b>          Dynamic microphone with flexible stem for remote stations for emergency calls, 49BME001 and 49BME012. <b>Approved to EN 54-16.</b></p>
		
	<b>49CVF001</b>	<p><b>WALL CABINET FOR MICROPHONE STATIONS</b>          Wall cabinet allowing surface mounting of emergency stations Art. 49BME001, 49BME012 and 49BME216, equipped with a front door with a transparent window. Colour: red. Box dimensions (LxHxD, mm) 370 x 320 x 137.8</p>
	<b>49MSC006</b>	<p><b>KIT OF 6 CERAMIC TERMINALS FOR SPEAKERS</b>          Kit of 6 pieces of ceramic terminals for the connection of speakers which require external wiring, such as horn models and one- or two-direction projectors.</p>



## ACCESSORIES



### 49DIR106



EN54-24



SPEAKERS



6 W

EVAC SYSTEMS



99 dB SPL

SPEAKERS



### 49DPQ110



EN54-24



SPEAKERS



10 W

EVAC SYSTEMS



102 dB SPL

SPEAKERS



### 49PLA106



EN54-24



SPEAKERS



6 W

EVAC SYSTEMS



97 dB SPL

SPEAKERS



### 49PLA110



EN54-24



SPEAKERS



10 W

EVAC SYSTEMS



97 dB SPL

SPEAKERS



### 49PRB105



EN54-24



SPEAKERS



5+5 W

EVAC SYSTEMS



90 dB SPL

SPEAKERS

### RECTANGULAR FLUSH-MOUNT SPEAKER EN54-24

The flush-mounted speaker Art. 49DIR106 has a body in black high-resistance self-extinguishing ABS and a removable front grille in white stainless steel. It is equipped with a 165 mm full-range loudspeaker and 100 V transformer with three power adjustment levels (6 / 3 / 1.5 W). These speakers are designed and constructed for use in emergency and evacuation systems. They are equipped with a ceramic terminal block and thermal fuse to safeguard the connection line to the loudspeakers, in the event that a fire damages one or more speakers connected to it.

**Approved to standard EN 54-24.**

### WALL-MOUNT ROUND SPEAKER, EN54-24

The round speaker Art. 49DPQ110 has a metal body with white powder coating. It is equipped with a 165 mm (HQ) full-range loudspeaker and 100 V transformer with four power adjustment levels (10 / 6 / 3 / 1.5 W). The speaker is designed for wall or ceiling installation and guarantees excellent long-lasting strength and durability in terms of the outer frame. It is equipped with a ceramic terminal block and thermal fuse to safeguard the connection line to the loudspeakers, in the event that a fire damages one or more speakers connected to it. Designed and constructed for use in emergency and evacuation systems. **Approved to standard EN 54-24.**

### 6W CAVITY CEILING LIGHT EN54-24

The flush-mounted light fitting Art. 49PLA106 has a metal body with white powder coating. It is equipped with a 130 mm full-range loudspeaker and 100 V transformer with three power adjustment levels (6 / 3 / 1.5 W). The light fitting is designed for discreet installations with minimal visual impact and is capable of integrating elegantly into all types of environment. Quick and easy mounting, thanks to the "WAGO" push-fit connector and the sturdy spring clips with protective hoods; it also has a fire retardant cap with rubber bushings for cable routing and a protective thermal fuse. Designed and constructed for use in emergency and evacuation systems.

**Approved to standard EN 54-24.**

### 10W CAVITY CEILING LIGHT EN54-24

The flush-mounted light fitting Art. 49PLA110 has a metal body with white powder coating. It is equipped with a 165 mm full-range loudspeaker and 100 V transformer with three power adjustment levels (10 / 5 / 2.5 W). The light fitting is designed for discreet installations with minimal visual impact and is capable of integrating elegantly into all types of environment. Quick and easy mounting, thanks to the "WAGO" push-fit connector and the sturdy spring clips with protective hoods; it also has a fire retardant cap with rubber bushings for cable routing and a protective thermal fuse. Designed and constructed for use in emergency and evacuation systems.

**Approved to standard EN 54-24.**

### 5+5W BIDIRECTIONAL SPOTLIGHT EN54-24

The two-way spotlight Art. 49PRB105 (5 + 5 W) has a water-resistant cylindrical frame (IP56) in white ABS with an adjustable aluminium backplate and cable L = 1 m. It is equipped with two 130 mm full-range loudspeakers and a 100 V line transformer with three power adjustment levels (10 / 5 / 2.5 W). Designed to achieve sound emission with significant directivity, it is particularly suitable for installation in hallways, corridors and particularly large rooms. Includes a protective thermal fuse and ceramic terminal, with everything housed in a junction box to make installation quicker and easier. Designed and constructed for use in emergency and evacuation systems.

**Approved to standard EN 54-24.**



### 49PRM120



EN54-24



SPEAKERS



SPEAKERS



EVAC SYSTEMS



20 W



99 dB SPL

SPEAKERS

### 20W MONODIRECTIONAL SPOTLIGHT EN54-24

The one-way spotlight Art. 49PRM120 has a water-resistant cylindrical frame (IP66) in white ABS with an adjustable aluminium mounting backplate and cable L = 1 m. It is equipped with a 130 mm full-range loudspeaker and a 100 V line transformer with four power adjustment levels (20 / 10 / 5 / 2.5 W). Designed to achieve sound emission with significant directivity, it is particularly suitable for installation in hallways, corridors and particularly large rooms. Includes a protective thermal fuse and ceramic terminal, with everything housed in a junction box to make installation quicker and easier. Designed and constructed for use in emergency and evacuation systems. **Approved to standard EN 54-24.**



### 49TRM115



EN54-24



SPEAKERS



SPEAKERS



106 dB SPL

SOUNDERS

### HORN SPEAKER, 15W EN54-24 IP66

The horn loudspeaker Art. 49TRM115 has a waterproof body (IP66), an ABS frame (UL94V0) which offers excellence resistance to impact and long-term durability, with an adjustable stainless steel backplate. It is equipped with a 100V line transformer with power adjustment across four levels (15 / 7.5 / 3.75 / 1.9 W) and has a low impedance operation option, 20 Ohm. Designed to provide high acoustic pressure, it is ideal for industrial applications, while the materials used enable its use outdoors or in particularly humid environments (e.g. swimming pools). Includes a protective thermal fuse and ceramic terminal. Designed and constructed for use in emergency and evacuation systems. **Approved to standard EN 54-24.**



### 49TRM130



EN54-24



SPEAKERS



SPEAKERS



110 dB SPL

SOUNDERS

### HORN SPEAKER, 30W EN54-24 IP66

The horn loudspeaker Art. 49TRM130 has a waterproof body (IP66), an ABS frame (UL94V0) which offers excellence resistance to impact and long-term durability, with an adjustable stainless steel backplate. It is equipped with a 100V line transformer with power adjustment across four levels (30 / 20 / 10 / 5 W) and has a low impedance operation option, 20 Ohm. Designed to provide high acoustic pressure, it is ideal for industrial applications, while the materials used enable its use outdoors or in particularly humid environments (e.g. swimming pools). Includes a protective thermal fuse and ceramic terminal. Designed and constructed for use in emergency and evacuation systems. **Approved to standard EN 54-24.**

# ADDRESSABLE SYSTEM

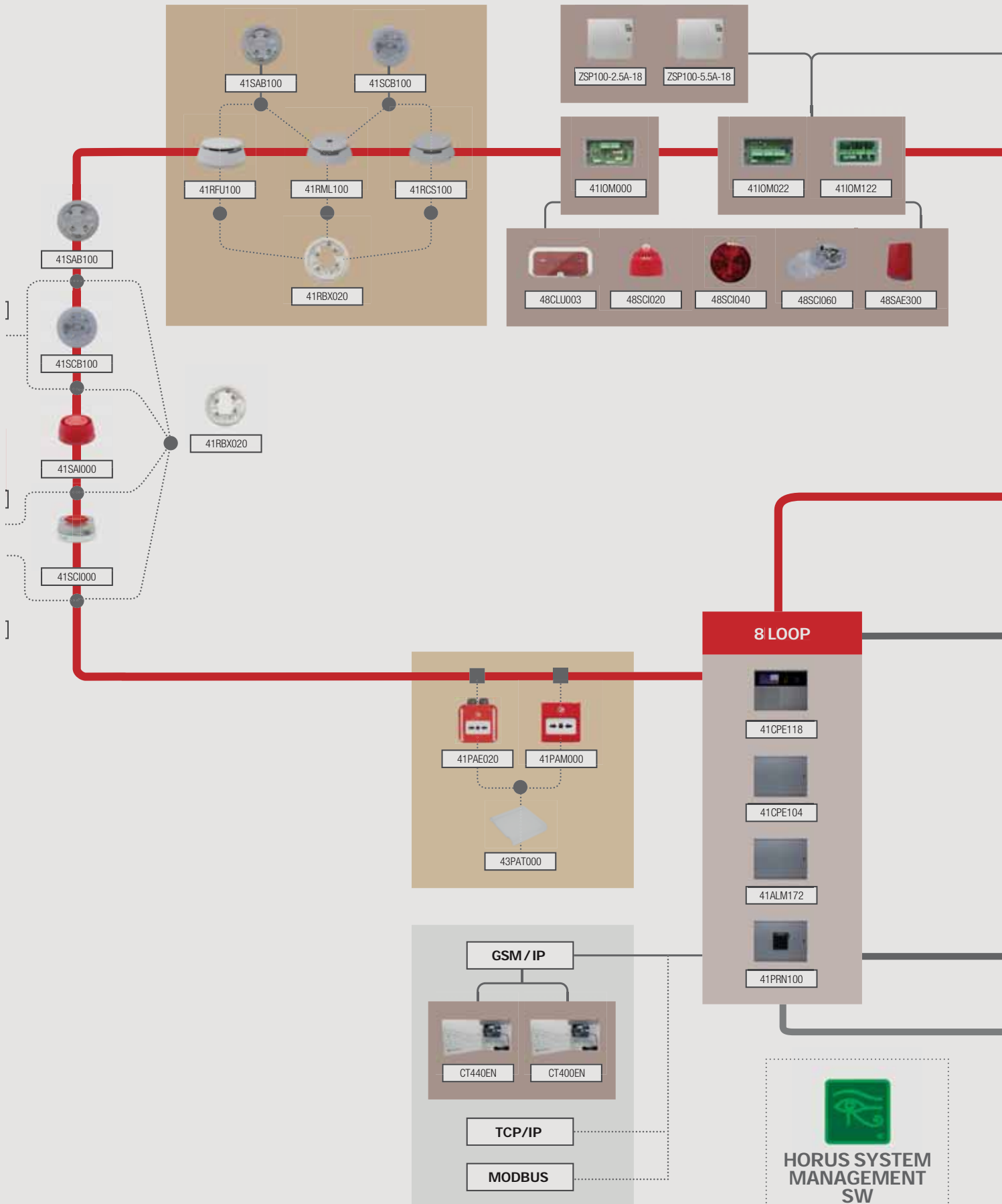



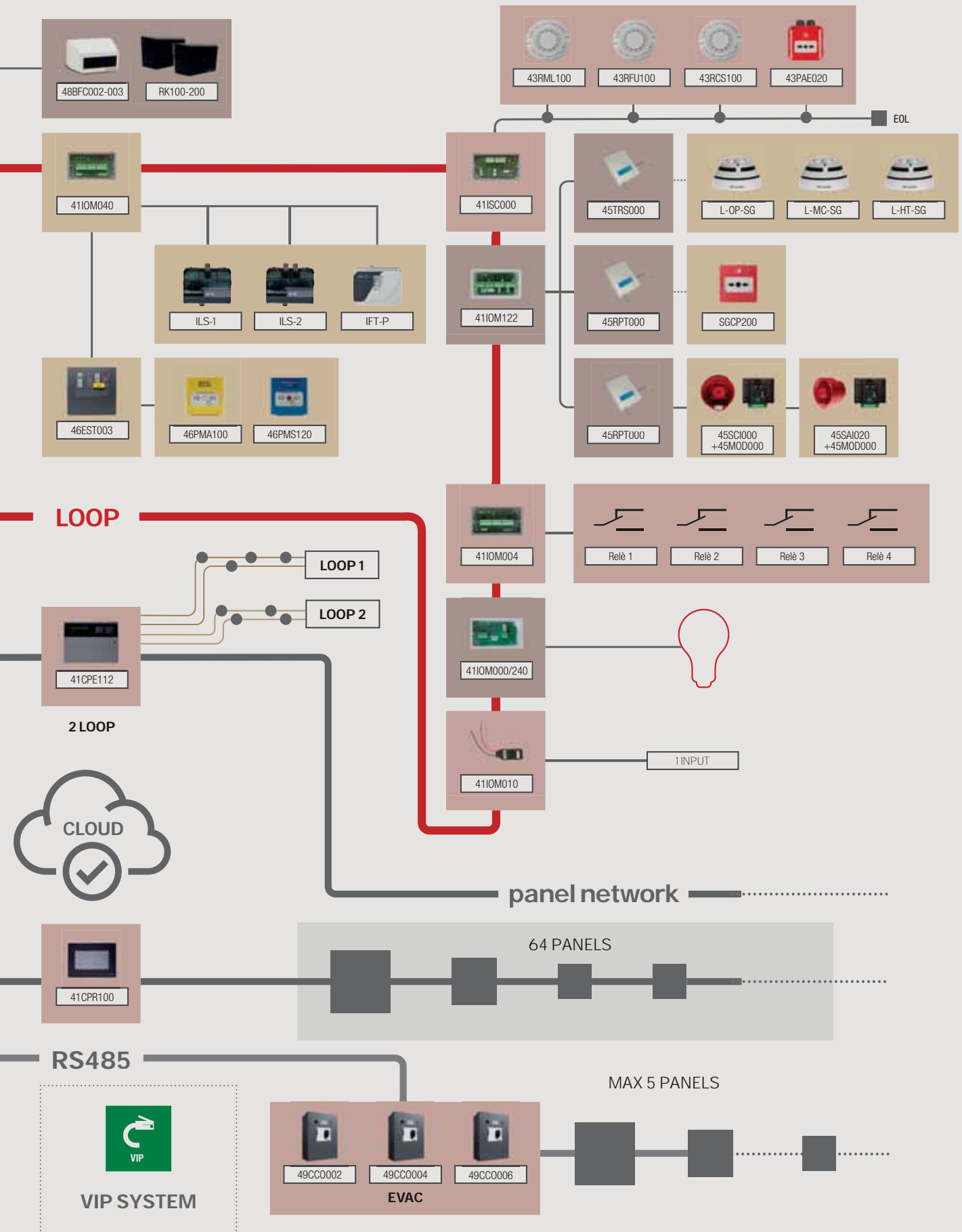



# CONVENTIONAL SYSTEM

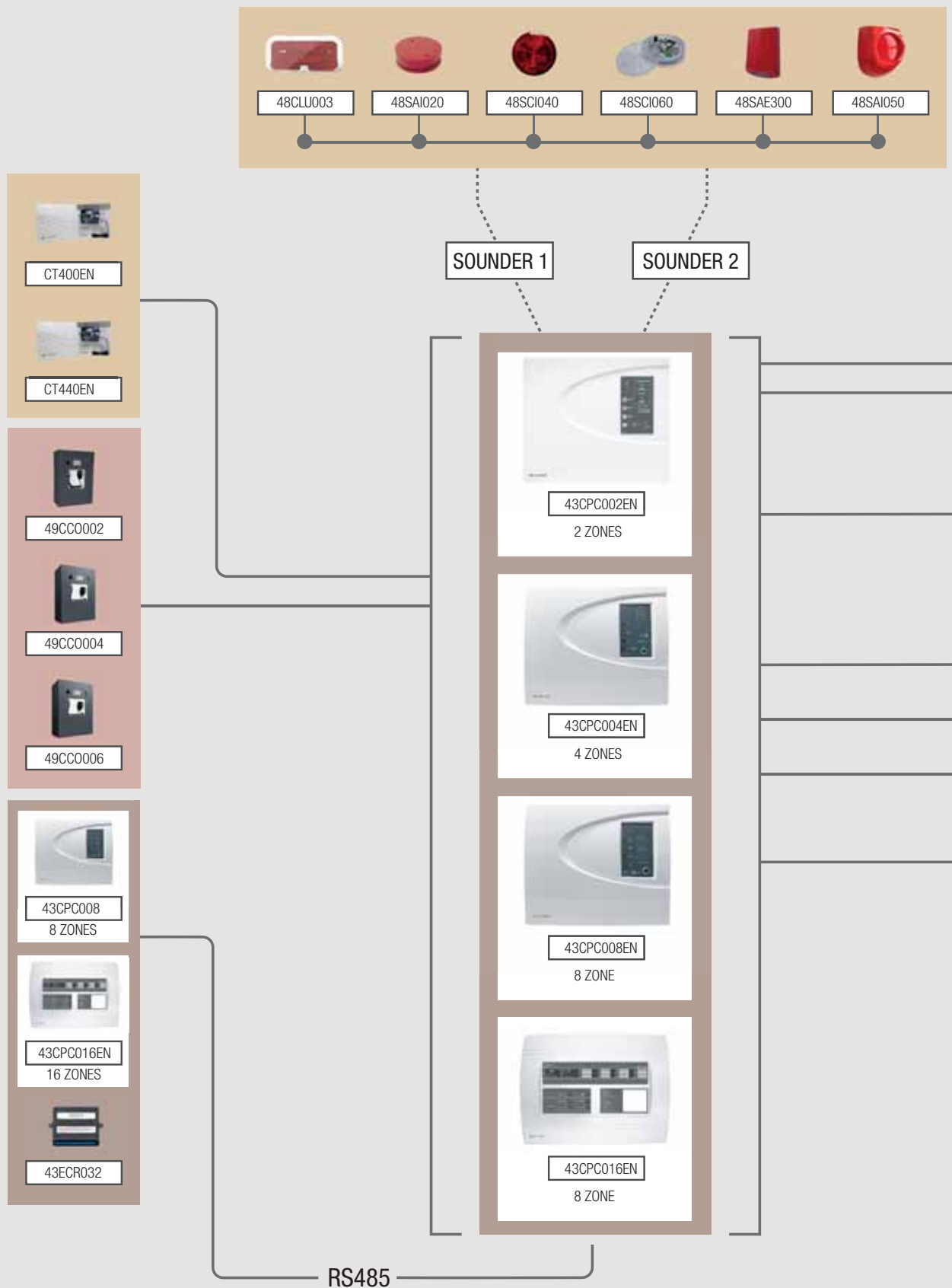

\*Control panel 43CPC008EN / 43CPC016EN can be connected to a second control panel 43CPC008 / 43CPC016EN for use as a repeater panel.

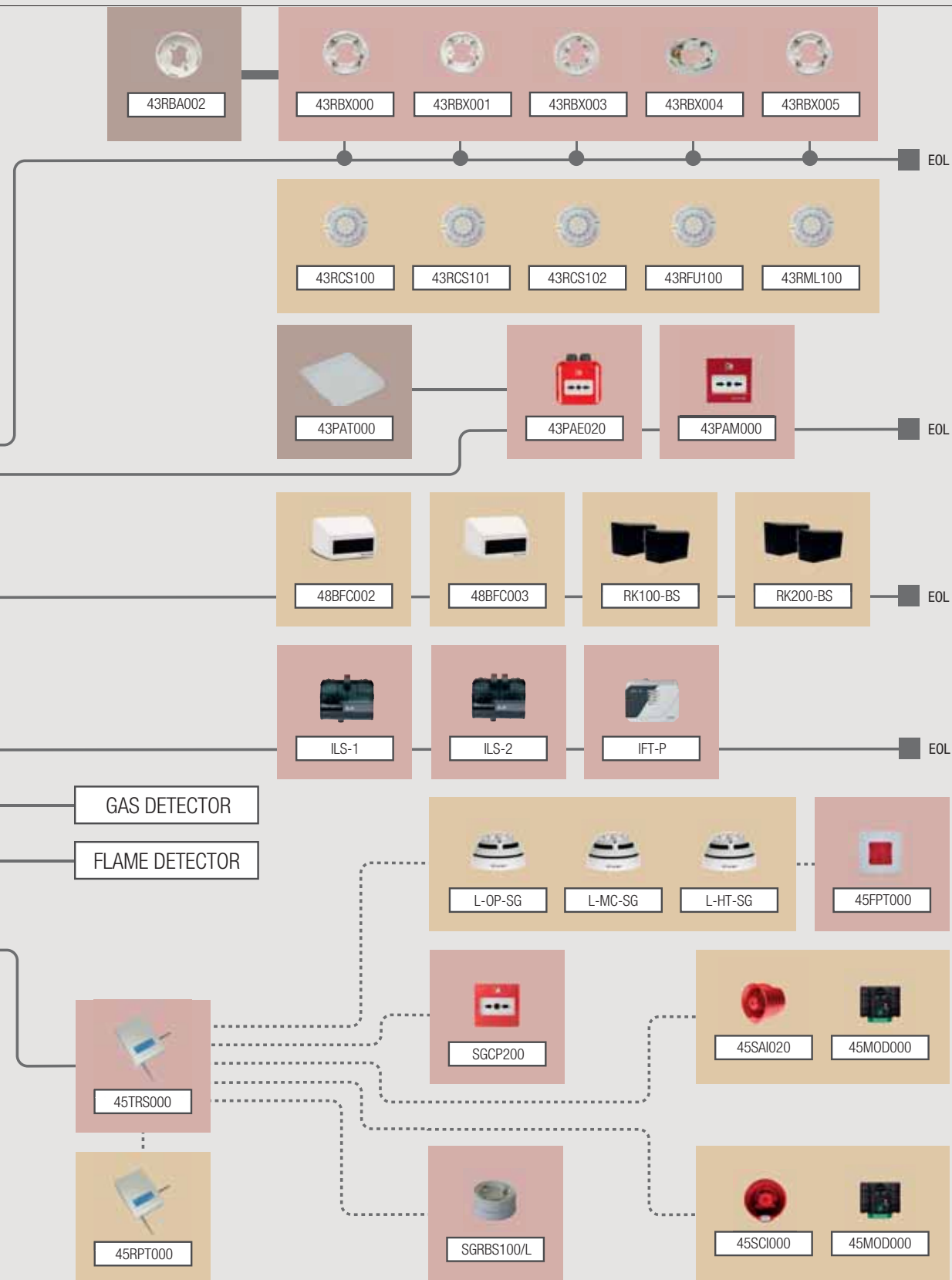



# EVAC SYSTEM

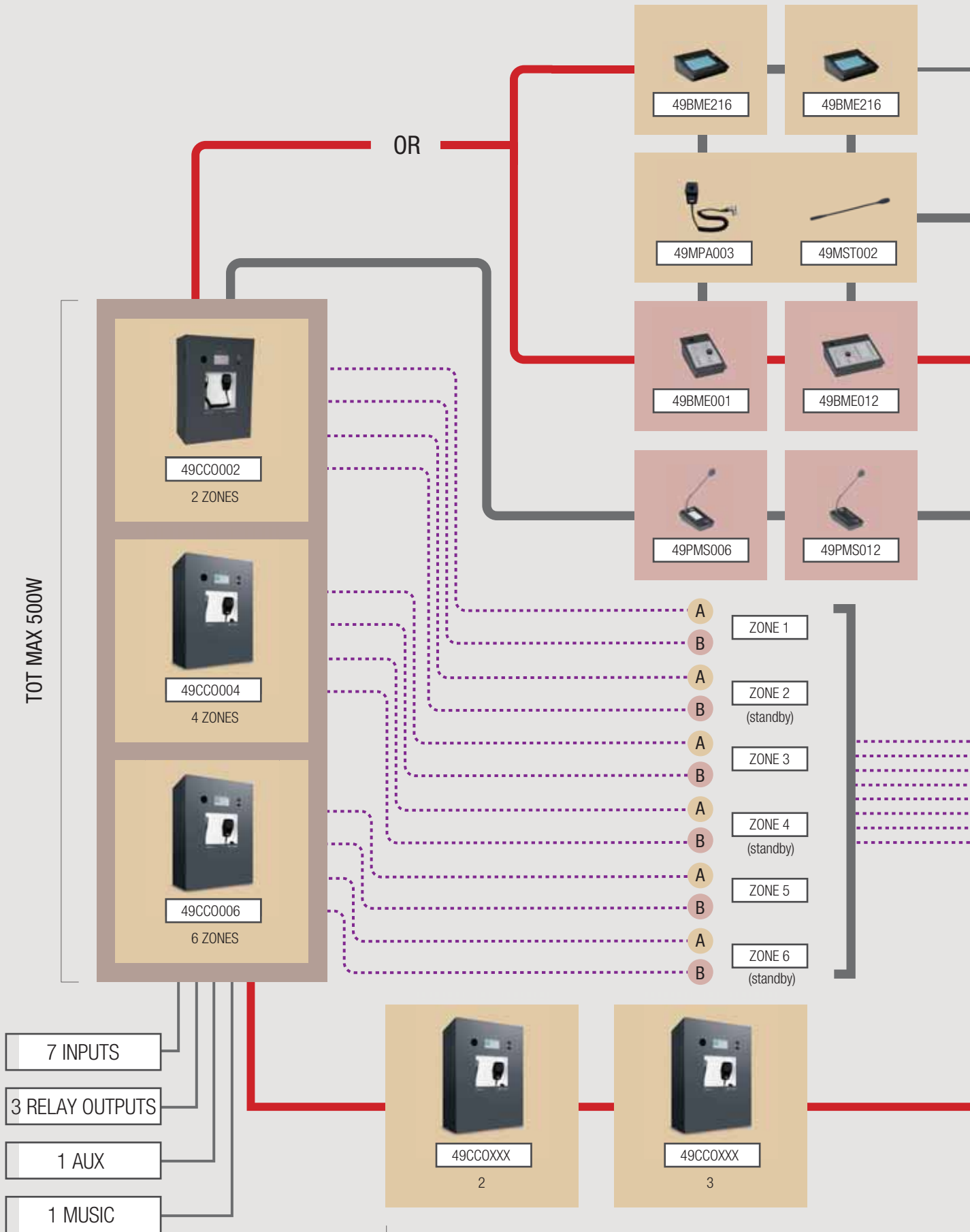

MAX 1000m - TOT 3000W - 36 ZONES

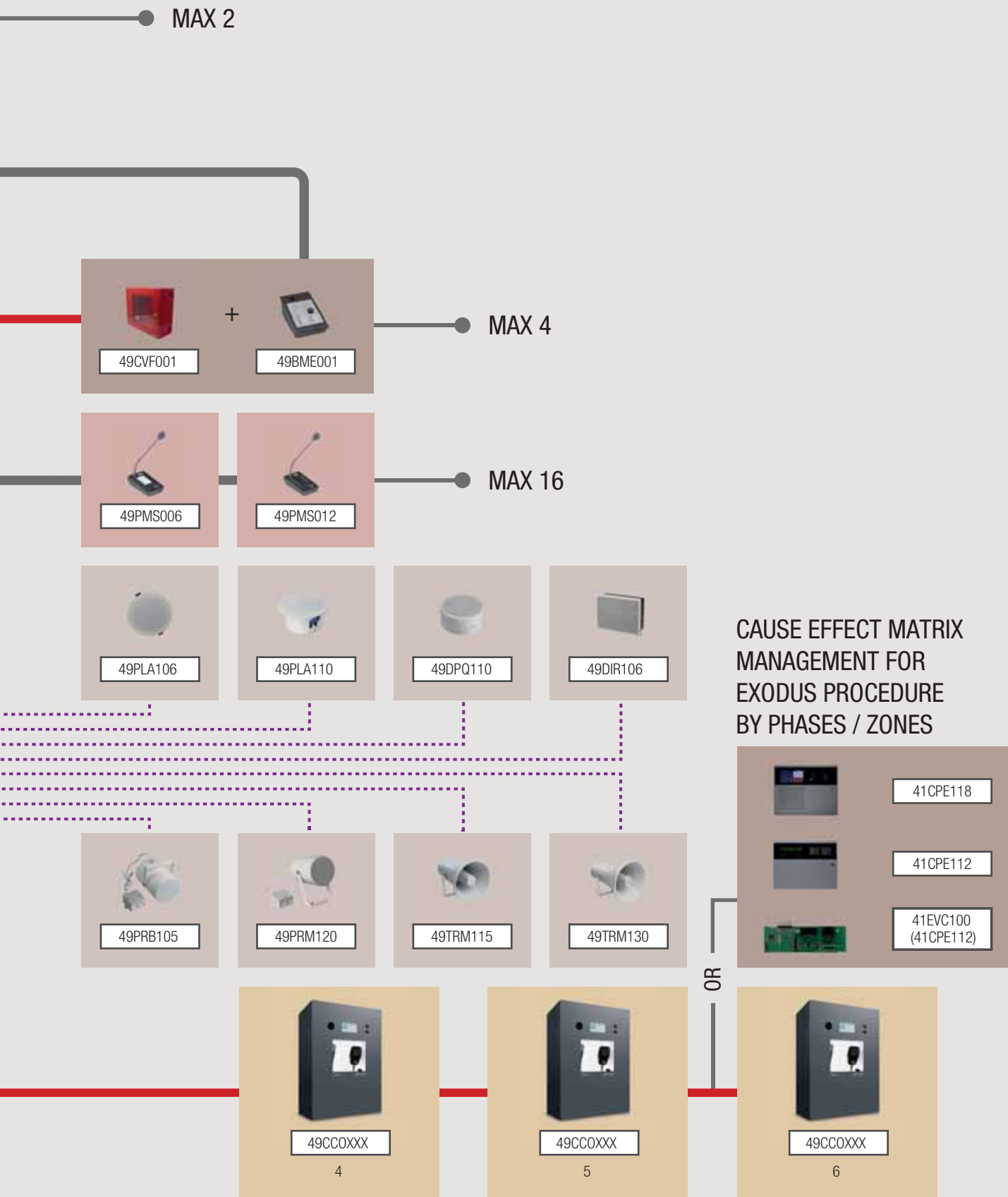

# REGULATIONS

## ASPIRATING SMOKE DETECTION SYSTEMS

### WHAT ARE THEY?

Aspirating smoke detectors draw in air for analysis from the protected area through pipes with holes or capillary pipes. The pipes convey the aspirated air to a sensor, which can be positioned at a distance from the protected area, thereby allowing easier and more economic maintenance. For suspended ceiling protection, for example, inspection hatches are not required as the network of pipes running through the suspended ceiling does not require maintenance; maintenance is only required for the machine, which can even be positioned outside the protected area and therefore in a more accessible location. Use a compressor to clean the holes and a vacuum cleaner to clean inside the coupling between the pipe and the machine. With an aspirating system, no wiring is required in the protected area; all that is required is the installation of a simple plastic pipe. A completely invisible detection system can be created by hiding the sampling pipe in the space above the suspended ceiling and using capillary pipes (small diameter pipes) with small holes to draw air from the protected area and convey it to the detection unit.

### WHERE SHOULD THEY BE INSTALLED?

This type of fire detection system is ideally suited to the following situations:

- Areas where detection would otherwise be difficult, such as, for example, in clean rooms, telephone exchanges, suspended ceilings, technical rooms, air ducts, etc..
- Aesthetically sensitive environments, such as museums, historic buildings, facilities with complex architecture etc..
- Environments where access to the system for maintenance purposes is difficult, such as cattle sheds, prisons, underground stations, etc..

### WHAT REGULATIONS APPLY?

All aspirating smoke detection systems must be approved to EN54-20 and must be installed in accordance with the guidelines in standard UNI9795:2013 and technical report UNI TR11694:2017. EN54-20 groups aspirating systems into 3 categories, A-B-C:

Furthermore, the maximum coverage of a single machine should not be over 1600 m<sup>2</sup> (the equivalent of a fire zone).

Product codes	ILS-1	ILS-2	IFT-P
Description	Aspirating detector 1 zone 1 detector	Aspirating detector 1 zone 2 channels	Aspirating smoke detector, 1 zone, 2 channels
Certification	<b>EN54-20</b>	<b>EN54-20</b>	<b>EN54-20</b>
Maximum number of holes class A	3	3+3	6+6
Maximum number of holes class B	6	6+6	18+18
Maximum number of holes class C	18	18+18	18+18
Sensitivity	0.06% to 6.0% obs/m	0.06% to 6.0% obs/m	0.001% to 20% obs/m

The table below specifies the sensitivity category of aspirating system required to protect premises according to height (UNI/TR 11694).

	Height (h) of the premises (m)				
	$h \leq 6$	$6 < h \leq 8$	$8 < h \leq 12$	$12 < h \leq 16$	$16 < h \leq 20$
Aspirating detectors (UNI EN54-20)	Class A, B, C	Class A, B, C	Class A, B	Class A	Class A

NOTE: for all areas with a height over 12 m, fire-tests must ALWAYS be carried out to confirm the actual operation of the installed system.

If the height of the protected premises exceeds 20 m, detection at intermediate height levels must also be provided in addition to the fire-tests.

### TOTAL SAMPLING APPLICATION EXAMPLE UNI/TR 11694

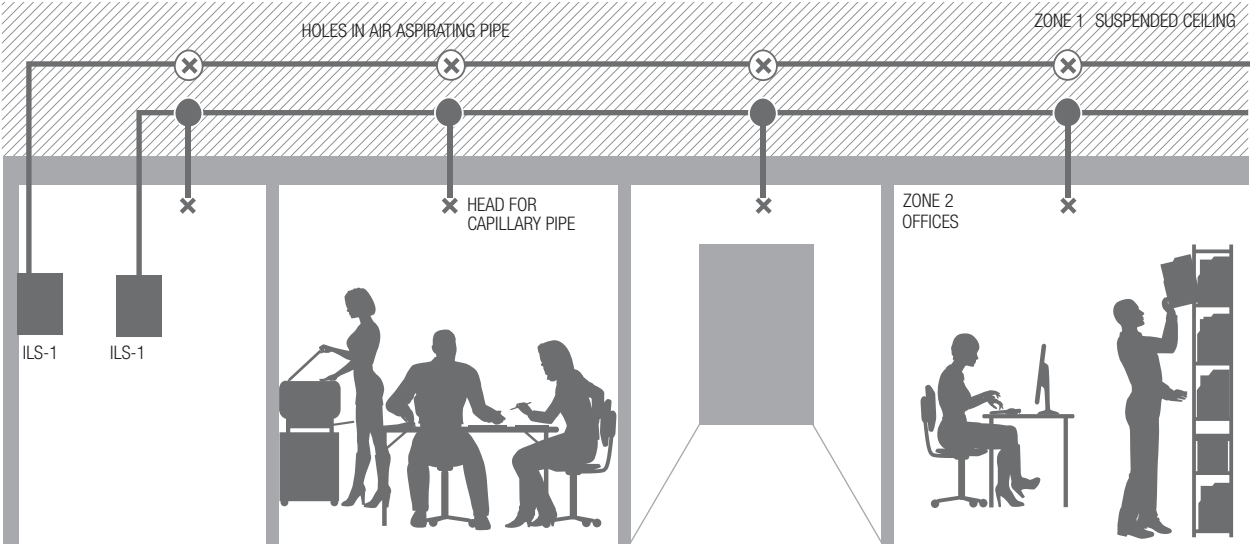

### PRIMARY SAMPLING APPLICATION EXAMPLE UNI/TR 11694

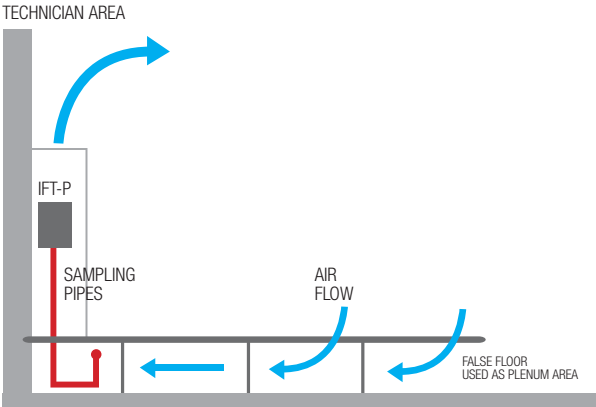

### OBJECT SAMPLING APPLICATION EXAMPLE UNI/TR 11694

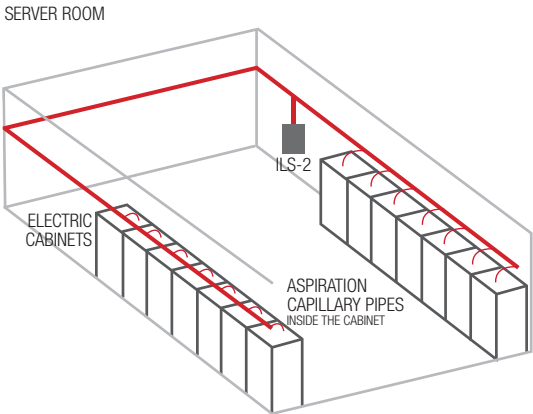

SOFTWARE AVAILABLE FOR SIZING THE ASPIRATING SYSTEM



# REGULATIONS

## LINEAR OPTICAL SMOKE DETECTORS

### WHAT ARE THEY?

A linear optical smoke detector is a fire detection device that uses the attenuation and/or modulation of one or more optical beams to detect smoke. They may consist of a powered active unit that performs the functions of emitter and receiver, and an unpowered passive unit designed specifically to reflect the transmitted beam of light back to the active unit. Another type is on with an active transmitter and receiver (tx-rx), where the infrared beam emitted by the transmitter is not reflected, but “captured” by the receiver which, depending on the set sensitivity level, will indicate linear optical detector alarm status or normal operating status. This type of sensor is frequently used in the case of longer distances between transmitter and receiver, and when the diameter of the IR beam needs to be smaller. When the active unit detects a difference between the light emitted and the light received, it triggers an alarm signal. The linear optical detector is able to determine whether an obscuration of the beam is due to the presence of smoke (partial blocking of the beam) or a physical object (total blocking of the beam). In the latter case, the unit relays a fault signal.

### WHERE SHOULD THEY BE INSTALLED?

The possibility to protect large spaces with just one linear optical detector not only obviates the need to install several point smoke detectors, along with the associated wiring and preparation work, but also enhances the aesthetics of the protected area while facilitating maintenance. Usually linear optical detectors are installed in:

- Large buildings with big open spaces, such as car parks, warehouses, dining rooms in restaurants and hotels, schools, long corridors, tennis courts and other sports facilities, hangars etc..
- Historic buildings and aesthetically sensitive environments, such as churches, museums, palaces, arenas, art galleries, luxury shops, etc..

### WHAT REGULATIONS APPLY?

The standards which regulate linear optical detectors are EN54-12, as regards product design, and UNI9795 for system installation. The latter standard specifies that the area covered by a single unit must not exceed 1600 m<sup>2</sup> (equivalent to a fire zone). This value is calculated on basis of the coverage of the beam emitted by a single unit, which must not exceed 15 m. As regards installation height, the standard specifies that in buildings with a flat roof the linear optical detector should be positioned within a distance from the ceiling equal to 10% of the total height of the room to be protected (see figures a and b). If this is not possible, the system should in any case be installed with a maximum distance from the ceiling equal to 25% of the total room height, and the number of units installed should be increased by 50% in relation to the number normally required.

Code	Distance from ceiling (minimum)	Coverage
48BFC000	30 cm	3-30 m
48BFC002	30 cm	5-50 m
48BFC003	30 cm	50-100 m
RK100-B	30 cm	25-120 m
RK100-BS	30 cm	25-120 m
RK200-B	30 cm	40-200 m
RK200-BS	30 cm	40-200 m
RK100-BS-EX	30 cm	25-120 m

THE DISTANCE FROM THE CEILING SHOULD ADHERE TO STANDARD UNI9795 AND TO THE OPERATIONAL DISTANCE OF THE PRODUCT



# APPLICATION EXAMPLE

SMOKE DETECTOR 48BFC000

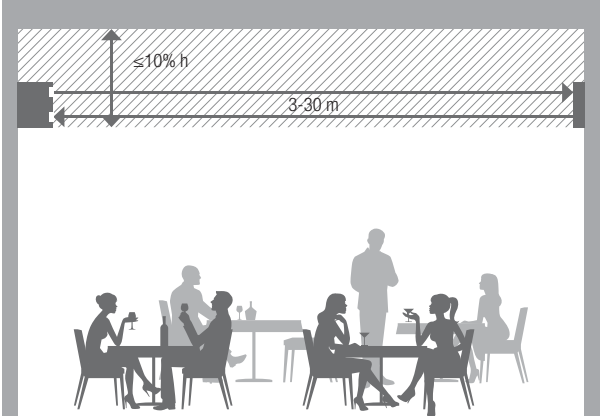

DINING ROOM - RESTAURANT

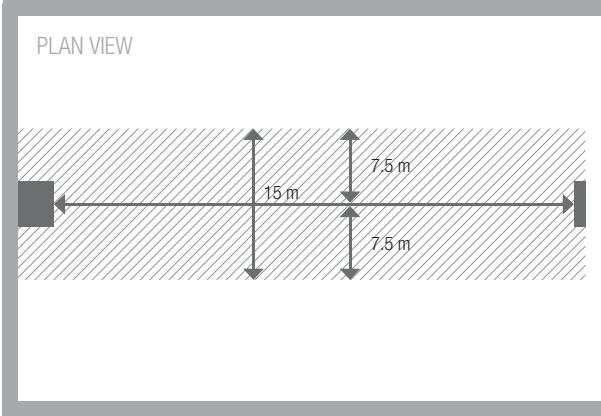

SMOKE DETECTOR 48BFC003

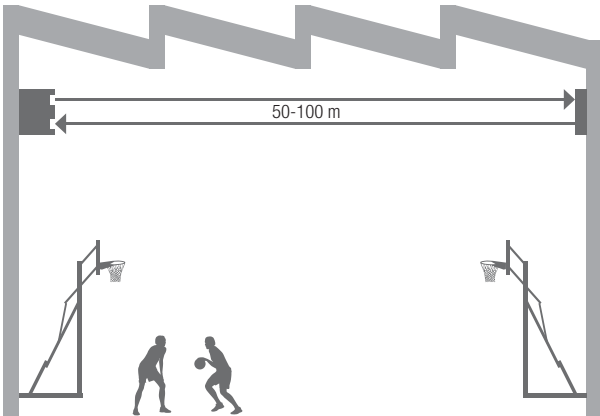

GYMNASIUM WITH PITCHED OR SHED-STYLE CEILING

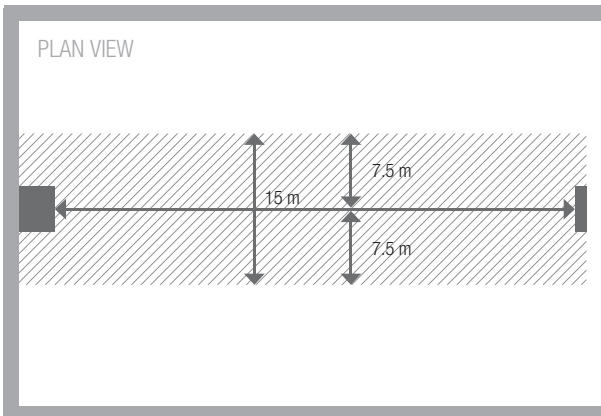

\*The percentage may vary depending on the maximum height of the gables

SMOKE DETECTOR RK200-B

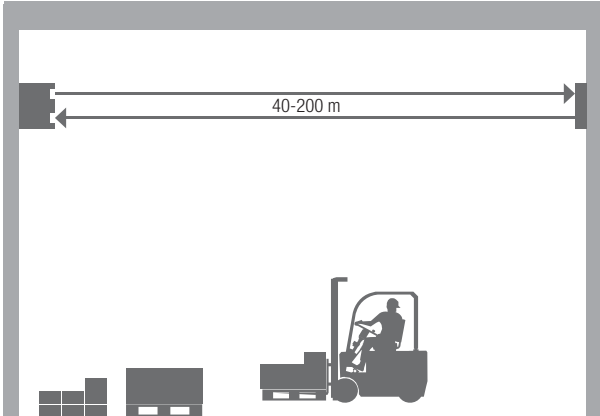

WAREHOUSE

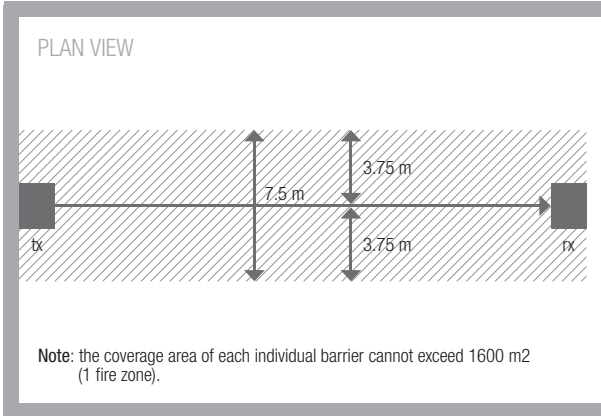

# REGULATIONS

## COMPACT VOICE EVACUATION PANELS APPROVED TO EN54-16 AND EN54-4

Voice evacuation systems are an increasingly essential element of fire detection systems. Leading evacuation with pre-recorded voice messages designed specifically for the type of system in which they are used, they help people inside the building to follow evacuation procedures in the safest way possible. These systems can also be used to broadcast music in normal conditions, giving priority to evacuation and alert messages in emergency conditions. This means these systems are ideal for use in public environments such as supermarkets, airports, schools, etc.

Comelit compact voice evacuation panels are approved in accordance with European standard EN54-16 for the voice evacuation part and EN54-4 for the power supply part.

### SPECIAL FEATURES

The new compact panels 49CC0002, 49CC0004 and 49CC0006 measure 62 x 43 x 24 cm, weighing significantly less than traditional evacuation panels, meaning they can be surface-mounted. These panels are equipped with a flat transducer which allows optimal consumption management during battery operation.

Each panel has a maximum power on the outgoing speaker lines of 500 W in total. The maximum number of control panels connected together in link via RS485 cable is 6.

### TABLE OF ACOUSTIC PRESSURE IN ENVIRONMENT TYPES

Acoustic pressure values in a free field are always expressed in dB SPL, or rather decibels calculated in Sound Pressure Level. In order to guarantee the spoken message can be understood, the average sound pressure level of the message must be at least 10 dBA at the existing environmental noise level. For a correct acoustic design, it is therefore essential to be aware of the noise level in the area in which the sound system needs to be set up; the table below provides a rough indication of the average values found in everyday environments.

ENVIRONMENT	NOISE (dB)
Stadium	85-95
Railway station	70-80
Workshop	60-70
Gym	60-70
Swimming pool	50-60
Meeting room	50-60
Supermarket	50-60
Car parks	50-60
Restaurant	45-65
Offices	45-55
Park	40-50
Hotel hallway	40-50
Classroom	30-50
Theatre	30-50
Church	30-50
Hotel bedroom	30-45
Hospital room	30-45

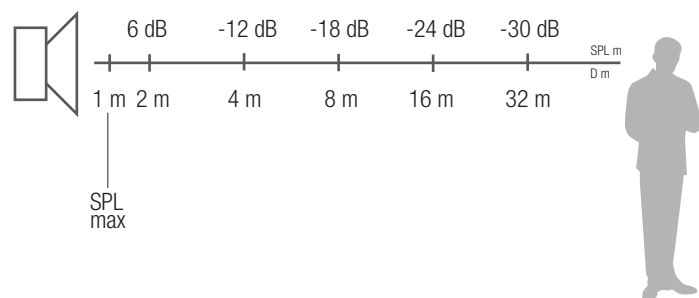

As you can see from the above image, the sound level produced by a speaker decreases as the distance from the listening point increases.

If the absorption due to the environment is not taken into account, we can see that as the distance doubles this contributes to a weakening of -6 dB in the sound pressure level.

# AUDIO DISTRIBUTION SYSTEM APPLICATION EXAMPLE, EVAC SYSTEMS

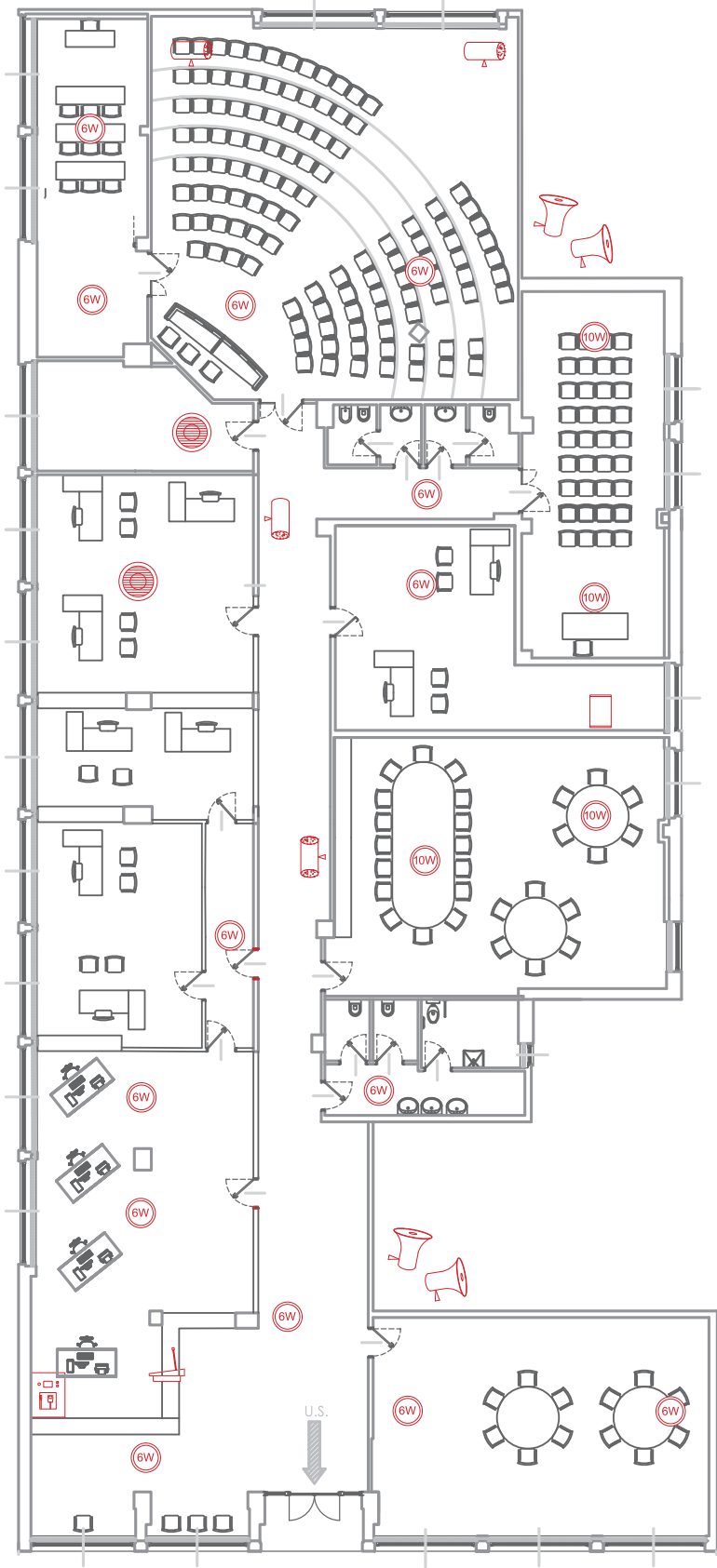

**VOICE EVACUATION SYSTEM LEGEND**

	COMPACT 6-ZONE EVAC PANEL EN54-16, EN54-4 Comelit 49CCO006
	ROUND METAL SPEAKER FOR WALL/CEILING, 10W EN54-24 Comelit 49DPQ110
	MONO-DIRECTIONAL SOUND PROJECTOR, 20W EN54-24 Comelit 49PRM120
	5+5W TWO-WAY SOUND PROJECTOR EN54-24 Comelit 49PRB105
	FLUSH-MOUNTED CEILING SPEAKER, 6W EN54-24 Comelit 49PLA106
	FLUSH-MOUNTED CEILING SPEAKER, 10W EN54-24 Comelit 49PLA110
	HORN SPEAKER, 15W EN54-24 Comelit 49TRM115
	HORN SPEAKER, 30W EN54-24 Comelit 49TRM130
	FLUSH-MOUNTED RECTANGULAR SPEAKER, 6W EN54-24 Comelit 49DIR106
	MICROPHONE STATION WITH 6-ZONE MICROPHONE Comelit 49PMS006

NB: example designed in accordance with UNI ISO 7240-19 - STI value shown via calculation performed with the help of specific calculation software



# REGULATIONS

## REGULATORY FRAMEWORK FOR FIRE PROTECTION SYSTEMS

### UNI 9795 - FIRE PROTECTION SYSTEMS

Specifies the criteria for the design and operation of fixed automatic fire detection and fire alarm systems. Fixed automatic fire detection must in all cases comprise:

- Automatic fire detectors
- Manual call points
- Control and indicating equipment
- Power supplies
- Fire alarm devices

### MANUAL CALL POINTS

Fixed automatic systems must include manual call points. Any faults and/or exclusions of the detectors must not put the alarm buttons out of service and vice-versa. 1 alarm button must be provided for each emergency exit. The distance between alarm buttons must be 15 metres (high risk activities) or 30 metres from the emergency exit point.

### AUDIBLE AND VISUAL ALARMS

The dimensions of audible and visual alarm devices must conform to the latest versions of the applicable standards (UNI 9795 ed. 2013; UNI TR 11607:2015), based on precise sound level parameters.

### UNI 11224:2019 - FIRE PROTECTION SYSTEM MAINTENANCE

Describes the procedures for the initial control, surveillance, regular checking, maintenance and general inspection of fire detection systems. It can also be applied where the fire detection system is used to activate an automatic extinguishing system or to implement fire safety devices. This standard applies both to new systems and to existing ones.

### UNI 11744:2019 - PATTERN OF UNIFIED ACOUSTIC FIRE ALARM AND PRE-ALARM SIGNAL

In force since April 2019, this specifies the pattern of the unified acoustic evacuation alarm and pre-alarm signal, used in acoustic fire detection and alarm devices.

- Acoustic pre-alarm signal: consists of an alternating sawtooth sound with a frequency variation from 800 to 970 Hz and a variation duration of 1 second.
- Acoustic evacuation alarm signal: consists of a continuous sound at 970 Hz  $\pm$  50 Hz.

### EN54-13:2017+A1:2019 - COMPATIBILITY AND CONNECTABILITY ASSESSMENT OF FIRE ALARM SYSTEM COMPONENTS

standard that sets out the compatibility and connection requirements for the components of a fire detection and fire alarm system. The components comply either with the requirements of UNI EN 54 or with a manufacturer's specification where there is no specific standard. This document also specifies requirements for the integrity of the fire detection and fire alarm system when connected to other systems.

The AFDS chapter S7 of the single fire prevention code is detailed below:

#### S.7.5 FIRE ALARM AND DETECTION SYSTEMS

1. Automatic fire detection systems (AFDS) designed and installed in accordance with standard UNI 9795 are considered a conforming solution. Conforming solutions are described in relation to the main and secondary function described in standard UNI EN 54-1 and listed in tables S.7-5 and S.7-6.
2. For the correct design, installation and operation of an AFDS in compliance with current regulations and standards adopted by the national standard-setting organisation, the compatibility and the correct interlinking of components must be checked, including the specific operating sequence of the functions which should be executed. The AFDS components checked in accordance with standard UNI EN 54-13 are considered a conforming solution.

### EXAMPLE INSTALLATION OF POINT SMOKE DETECTORS, DISTANCE FROM CEILING

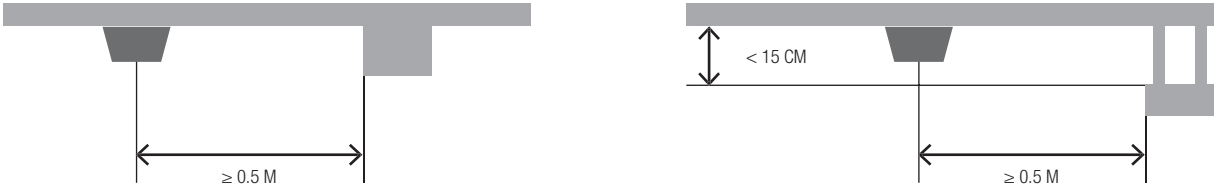

### EXAMPLE INSTALLATION OF HEAT AND SMOKE DETECTORS

CASE 1: ROOM WITH DIMENSIONS THAT ARE SIMILAR TO EACH OTHER

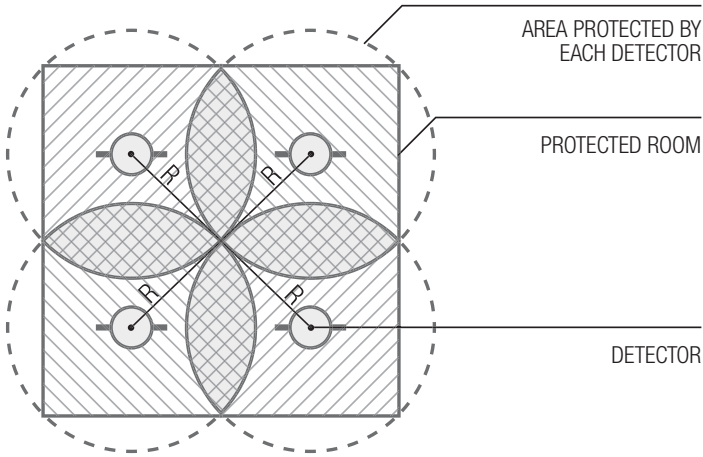

CASE 2: ROOM WITH DIMENSIONS NOT SIMILAR TO EACH OTHER (CORRIDOR)

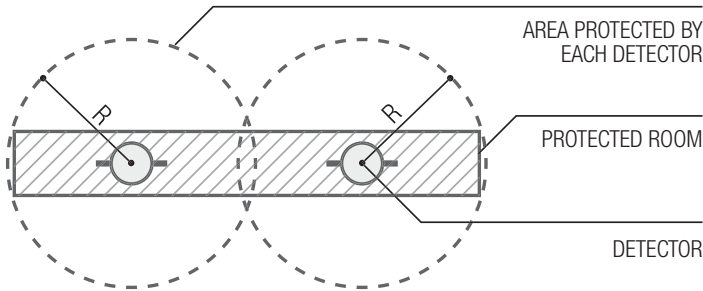



# LOOP LENGTH CALCULATORS AND BATTERY CALCULATOR

Comelit provides tools that can correctly calculate the dimensions of addressable fire alarm systems, precisely identifying any potential problems before the system is installed. You can therefore calculate the cross-section and maximum length of the cable to use in accordance with the devices installed, as well as the maximum current consumption of the devices, and thereby determine whether the panel will be able to control them. A second tool calculates the minimum capacity of the battery to be installed to ensure a certain level of autonomous operation in the event of a mains power outage. All this is possible simply by entering the number of devices that will be installed.

There are 3 calculation tools available:

- Tool for calculating cable cross-section and length and the current absorption for all Comelit addressable panels
- Battery calculator for the 41CPE112 and 41CPE012 addressable panels.
- Battery calculator for the 41CPE118 and 41CPE024 addressable panels.



# FIRE-VIP INTEGRATION

Comelit offers an innovative solution that integrates the world of IP video entry with fire detection systems. Taking the systems installed in a residential/commercial context as a launch point, the company has developed module 1467 which can be used to integrate fire detection panels (LOGIFIRE and ATENA) with all ViP IP video entry systems. The 1467 module uses MODBUS TCP/IP protocol to acquire all the information relating to the fire detection control panel alarms and distributes it to users via the ViP System. In addition to the classic audio-visual indications specified by regulations, a further alert message is sent to the individual apartments/offices via the video entry stations. Every single monitor can be programmed to receive Pre-alarm, Alarm and Evacuation signals. The logic for sending signals to each individual monitor is fully programmable by type and event, according to the floor or zone linked to the detection of the fire. Where required, any porter switchboards may receive not only all the information sent to the monitors, but also fault indications relating to the fire detection panel. The system also allows, where intended, the transmission of programmable notifications directly via the MyComelit APP.

## FIRE VIP Integration

Example of interfacing between fire alarm control panel 41CPE118 and ViP / FIRE 1467 module

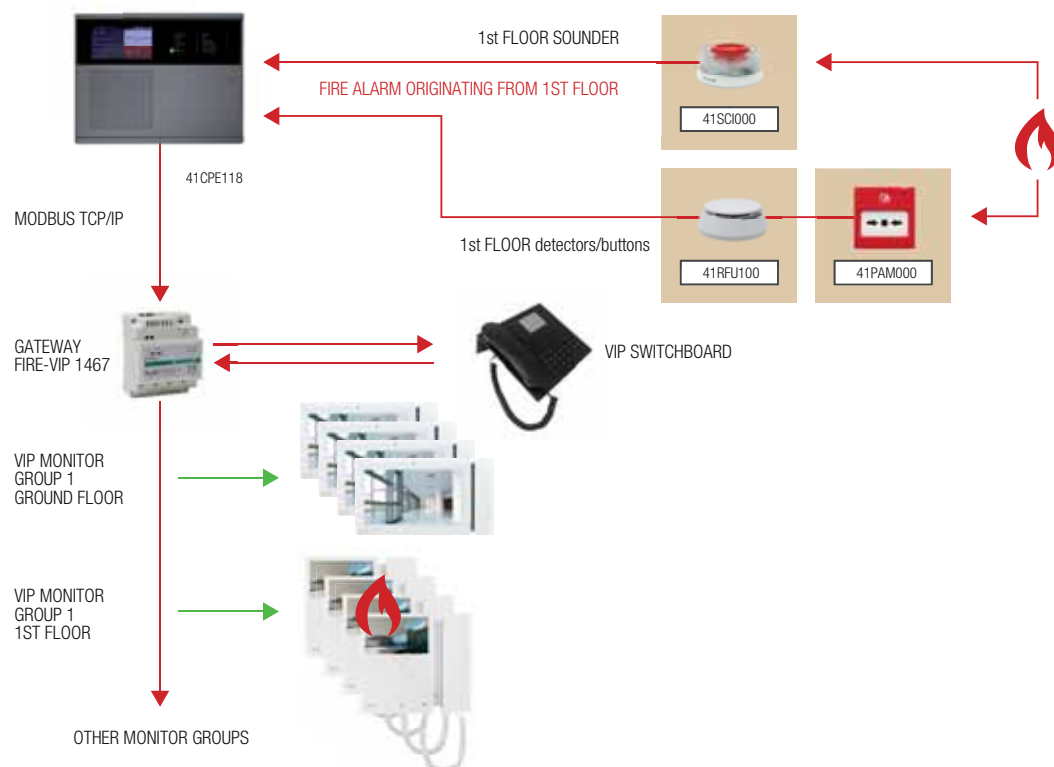



# LOGI PROG SW

---

The new **LogiProg** software is a tool available to the installer for the configuration and management of the entire Comelit addressable range.

The simple and intuitive interface allows linear programming of control panel parameters, such as the description of individual devices, zones, logics, timings and delays required during system startup, even in OFFLINE mode, so that the installer is able to pre-program the system without being directly connected to the control panel. Connection with the control panel can take place via mini USB cable or directly in TCP/IP.

The software can also be used to download a copy of the programming in EXCEL format, the control panel Event log and the maintenance report with the degree of contamination specified for each individual detector.

The system configuration is saved in TDF format, a special file that can in turn be uploaded to the **LogiManager** dedicated supervision software while retaining all the parameters relating to Zones and Devices entered during configuration and their descriptions, thereby significantly reducing the time it takes to import points and create maps.





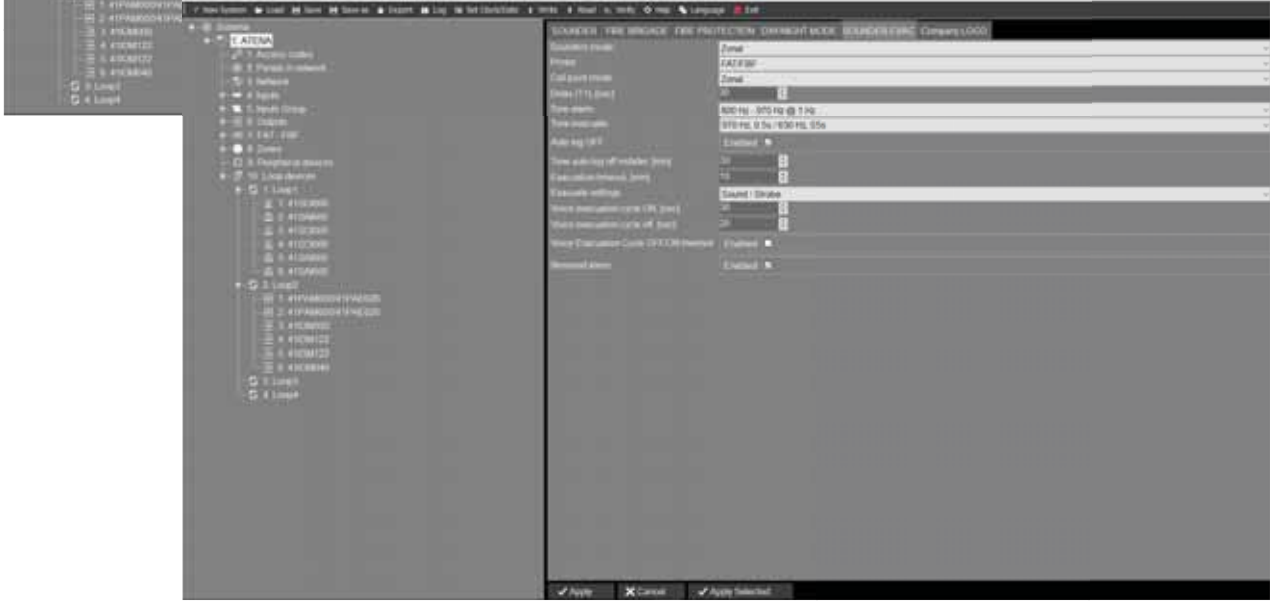
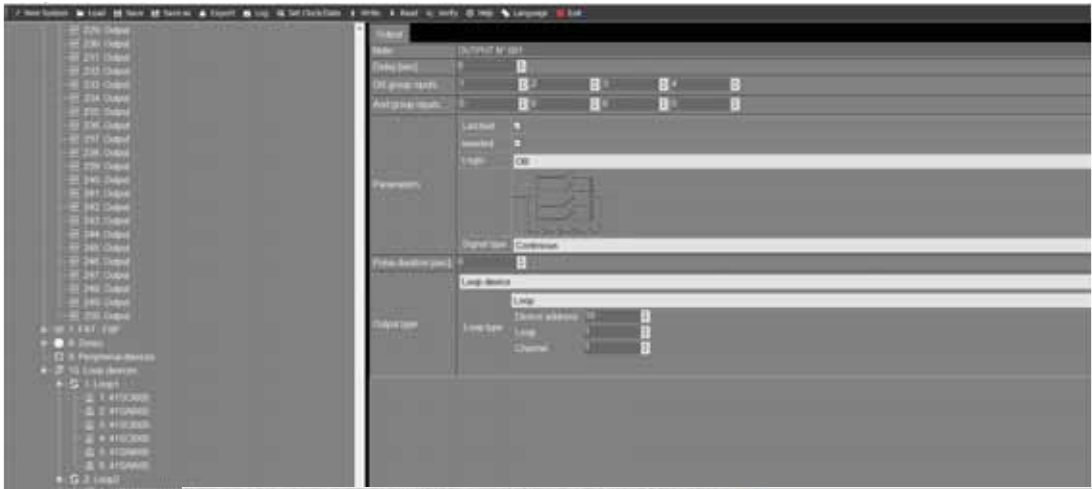



# HORUS SYSTEM MANAGER

---

The aim of fire detection systems is to guarantee the safety of people and property.

In particular, when it comes to large and complex systems or multi-level structures, supporting graphics become absolutely essential to minimising reaction times.

For this reason, a correct and instant management of alarm situations facilitates the management of any false alarms or allows targeted and effective intervention to take place as quickly as possible.

Horus is the ideal tool to satisfy this requirement.

It immediately captures the attention of the personnel in charge, highlighting that there is a fire alarm; it provides all the necessary information relating to the exact location of the event, guiding the personnel to the exact point requiring intervention for checking purposes. If it is a false alarm, the authorised operator will be able to exclude the individual device which generated the alarm.

Horus is also the integration platform for all Comelit systems.

One possible implementation is pairing it with the CCTV system, which makes it possible to view a pop-up of the images captured by the cameras involved in the event.





Connection between control panels in the LOGIFIRE and Horus series takes place via MODBUS TCP/IP protocol. Horus can manage an unlimited number of control panels, maps and points.

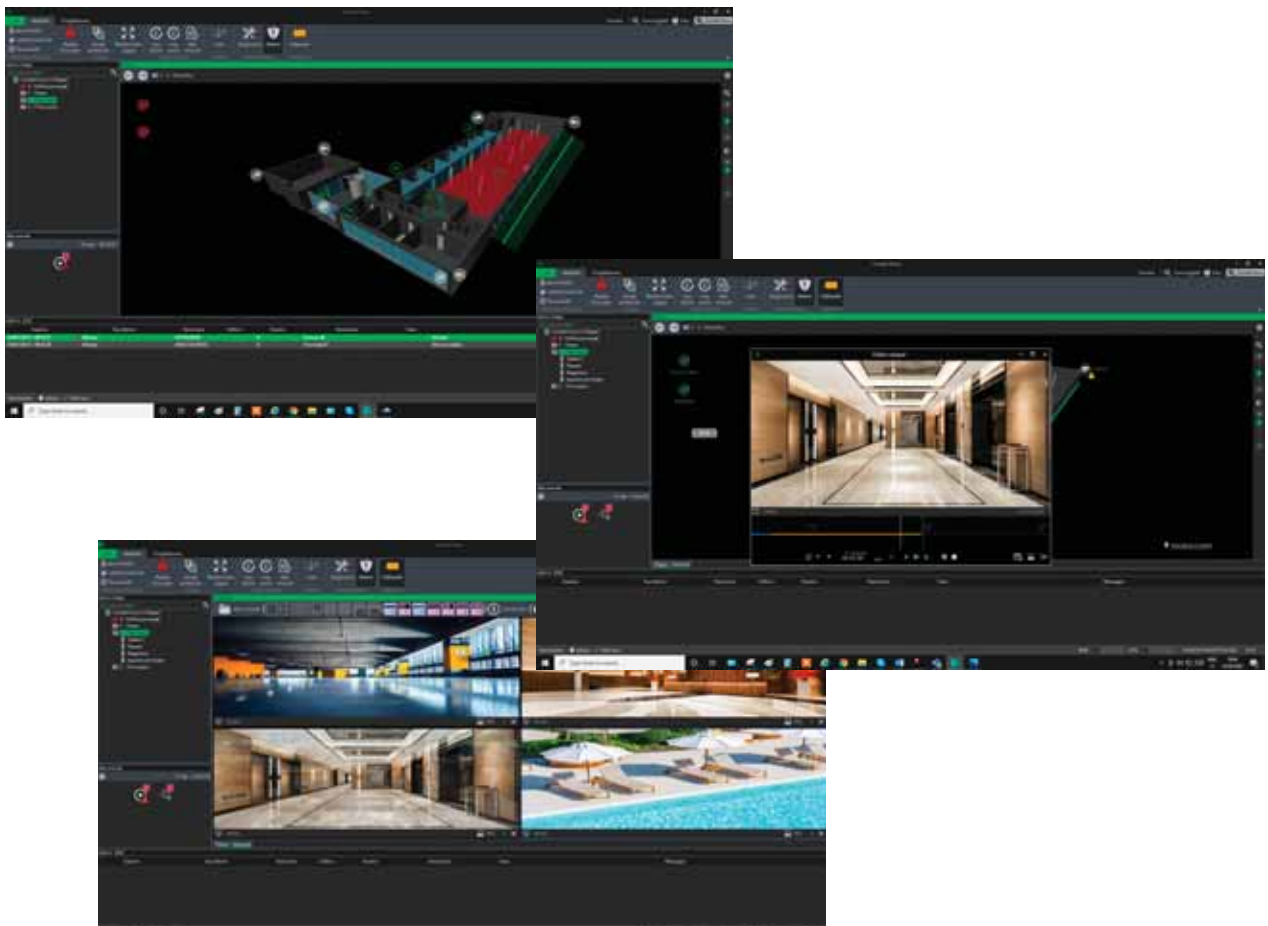

The maps can be imported in Bitmap, Vector or DWG format, if necessary using the original planimetry of the site to be monitored. Horus also offers an innovative function as it allows any planimetry to be divided into logical views, for a full-screen zoom in the event of an alarm so that the zone affected by the alarm can be shown. The devices are added to the map with customisable icons and can be excluded individually depending on authorisation level; they switch from static to flashing in different colours according to status (Alarm - Fault - Exclusion). The control panel icon makes all built-in function available, such as reset, buzzer silencing or sounder silencing. In the event of a verified alarm, the system allows delay times to be cancelled and the evacuation procedure to be started. The system can also be used to monitor all control panel alarm/fault/anomaly statuses to allow real-time diagnostics.







# THE ADDRESSABLE RANGE





FIRE ALARM CONTROL PANELS				
				
	ITEM CODE	<b>41CPE118</b>	<b>41CPE112</b>	<b>41CPE104</b>
MAIN FEATURES	MODEL	Addressable fire panel, 1-8 loops, LOGIFIRE series	Addressable fire panel, 1-2 loops, logifire series	4-loop expansion box, logifire series
	NUMBER OF LOOPS	1 as standard, can be expanded to 4 with 3 x 41ECL120, up to 8 with box 41CPE104 (1 as standard)	1 standard, can be expanded to 2 with expansion device 41ECL022	1 standard, can be expanded to 4 with expansion device 41ECL120
	LOOP EXPANSION COMMUNICATION PROTOCOL	Comelit	Comelit	Comelit
	MAX. NUMBER OF DEVICES PER LOOP	250	250	250
	NUMBER OF DETECTION ZONES AVAILABLE	500	48	
	MAX. NUMBER OF DEVICES PER ZONE	32	32	
	PROGRAMMABLE LOGIC FUNCTIONS	AND/OR		
	MAX. NUMBER OF LOGIC INPUTS	250		
	MAX. NUMBER OF LOGIC OUTPUTS	250		
	CONNECTIVITY	LAN, RS485	RS485, LAN (module 41ECN000 for supervision SW)	
	ALARM LEVELS (T1 AND T2)	Yes	Yes	
	INTERNAL BUZZER	Yes	Yes	
	EVACUATION COUNTDOWN (T3)	Yes	Yes	
	SOUNDER ACTIVATION DELAY	1 - 10 minutes	1 - 10 minutes	
	DETECTION WITH CONFIRMATION (DUAL ACTION)	Yes	Yes	
	NUMBER OF PASSWORD-PROTECTED ACCESS LEVELS	3	3	
	ACTIVATION DELAY MANAGEMENT	Yes	Yes	
	MAXIMUM NUMBER OF EVENT LOGS	10240	10000	
	MULTI-LANGUAGE DISPLAY MENU	Yes	Yes	
	EVAC PANEL INTERFACING MODULE	Yes, supplied	Yes, optional Art. 41EVC100	
	MAXIMUM NUMBER OF EVAC PANELS THAT CAN BE CONNECTED	5	5	
	OPTIONAL ADDITIONAL POWER SUPPLY UNIT	Yes, Art. 41ALM172		
	OPTIONAL THERMAL PRINTER	Yes, Art. 41PRN100	Yes, Art. 41PRN100	
	INSTALLATION IN MODULAR STRUCTURES	Yes	Yes	Yes
	FLUSH MOUNTING	Yes, Art. 48BIA100	Yes, Art. 48BIA100	Yes, Art. 48BIA100
	OPERATING MODE WITH/WITHOUT SUPERVISION (DAY/NIGHT)	Yes	Yes	
	REMOTE PANEL CONTROL	Yes	Yes	
	NUMBER OF CONTROL PANELS THAT CAN BE CONNECTED VIA ETHERNET	64 with integrated TCP/IP interface	64 with Art. 41ECN000	
	PROGRAMMING VIA PC	With programming software	With programming software	With programming software
	LOCAL PROGRAMMING	Via menu on colour touchscreen display	Via menu on display and keypad	
SENSOR ADDRESSING WITH AUTO-ACQUISITION OF LOOP DEVICES	Yes	Yes		
SENSOR ADDRESSING WITH ELECTRONIC PROGRAMMER 41SPG000	Yes	Yes		
BACKWARDS COMPATIBLE WITH PREVIOUS SERIES OF COMELIT ADDRESSABLE SENSORS	Yes	Yes		
CERTIFICATION STANDARD	EN54-2, EN54-4, EN54-13	EN54-2, EN54-4, EN54-13	EN54-2, EN54-4, EN54-13	

FIRE ALARM CONTROL PANELS				
				
	ITEM CODE	<b>41CPE118</b>	<b>41CPE112</b>	<b>41CPE104</b>
HARDWARE SPECIFICATIONS	DIMENSIONS (W X H X D - MM)	430 x 330 x 150	430 x 330 x 150	430 x 330 x 150
	IP PROTECTION RATING	IP30	IP30	IP30
	ENCLOSURE	Metal	Metal	Metal
	COLOUR	Grey, RAL 7045	Grey, RAL 7045	Grey, RAL 7045
	DISPLAY	Resistive 7" touchscreen	Alphanumeric LCD, 4 rows of 40 characters	N/A
	WEIGHT WITHOUT BATTERIES (g)	7000	7000	6500
	ZONE STATUS INDICATOR LEDs	200	16	
	REDUNDANT CPU	Yes		
	PROGRAMMING PORTS	Micro USB-B, LAN (RJ45)	Micro USB-B	
	ETHERNET CONNECTION	Yes	Yes (for supervision via SW) optional Art. 41ECN000	
	MAX. NUMBER OF PANELS ON REDUNDANT RS485 NETWORK	64, with optional module 41ECB000	64, with optional module 41ECB000	
	PROTECTION UPON ACCESS	Using a special mechanical key	Using a special mechanical key	Using a special mechanical key
	DEDICATED INPUTS FOR INTERFAC. WITH EXTINGUISHING SYSTEMS	3	3	
	OPERATING TEMPERATURE (°C)	-5 - 40	-5 - 40	-10 - 50
	OPERATING HUMIDITY (max % RH)	(93 ± 3)% @ 40°C	(93 ± 3)% @ 40°C	(93 ± 3)% @ 40°C
MAX. CONNECTION CABLE CROSS-SECTION (mm <sup>2</sup> )	0.4 - 2.0	0.4 - 2.0	0.4 - 2.0	
ELECTRICAL SPECIFICATIONS	MAIN POWER SUPPLY	110-230 VAC / 50-60 Hz	110-230 VAC / 50-60 Hz	110-230 VAC / 50-60 Hz
	BACKUP POWER SUPPLY (BATTERIES NOT SUPPLIED)	1 x 12 VDC - 18 Ah	1 x 12 VDC - 18 Ah	1 x 12 VDC - 18 Ah
	AUXILIARY DEVICES POWER SUPPLY OUTPUT	1 (24 VDC/0.3 A)	1 (24 VDC/0.5 A)	1 (24 VDC/0.3 A)
	PROGRAMMABLE RELAY OUTPUTS WITH FREE CONTACT (NO/NC)	4 (30 V@ 10A)	4 (15A@24 VDC)	
	MONITORED OUTPUTS FOR SIRENS	1 (24 VDC @ 1A)	2 (24 VDC @ 0.5A each)	1 (24 VDC @ 1A)
	MONITORED OUTPUTS	3 (Alarm transmission, Extinguishing, Fault) 100 mA @ 24 VDC each	3 (Alarm transmission, Extinguishing, Fault) 300 mA @ 24 VDC each	



# THE ADDRESSABLE RANGE



FIRE ALARM ACCESSORIES			
			
	ITEM CODE	<b>41PRN100</b>	<b>41CPR100</b>
MAIN FEATURES	MODEL	Thermal printer, logifire series	Repeater panel, logifire series
	COMPATIBLE CONTROL PANELS	41CPE118, 41CPE112	41CPE118, 41CPE112
	MAX. NUMBER OF PANELS ON REDUNDANT RS485 NETWORK		64, with optional module 41ECB000
	NUMBER OF CONTROL PANELS THAT CAN BE CONNECTED VIA ETHERNET		64 with integrated TCP/IP interface
	PROGRAMMING PORTS		Micro USB-B
	PROGRAMMING VIA PC		With programming software
	LOCAL PROGRAMMING		Via menu on display and keypad
	DISPLAY		Resistive 7" touchscreen (159x88 mm)
	INTERNAL BUZZER		Yes
	SUPPOED FONT TYPES	12x24 points and 9h17 points	
	PRINT DENSITY	8 points/mm. 576 points/line	
	PRINT SPEED	170 mm / sec.	
HARDWARE SPECIFICATIONS	WIDTH (mm)	430	227
	HEIGHT (mm)	330	166
	DEPTH (mm)	150	38
	IP PROTECTION RATING	IP30	IP30
	MATERIAL	Metal	ABS
	COLOUR	Grey, RAL 7045	White RAL 9002, black frame
	WEIGHT (g)	5500	700
	FLUSH MOUNTING	Yes	Yes, Art. 41KPR102
	DESK BASE MOUNTING		Yes, Art. 41KPR101
	INSTALLATION IN MODULAR STRUCTURES	Yes	
	OPERATING TEMPERATURE (°C)	-10 - 50	-5 - 50
	OPERATING HUMIDITY (max % RH)	(93 ± 3)% @ 40°C	(93 ± 3)% @ 40°C
ELECTRICAL SPECIFICATIONS	POWER SUPPLY VOLTAGE	230 VAC (+/-10%), 50 Hz	24 VDC
	MAXIMUM ABSORPTION (mA)		220

FIRE ALARM PANEL ACCESSORIES						
						
	ITEM CODE	41ECL120	41ECL022	41ECB000	41ECN000	41EVC100
MAIN FEATURES	COMPATIBLE CONTROL PANELS	41CPE118, 41CPE024	41CPE112, 41CPE012	41CPE118,41CPE112, 41CPE024, 41CPE012	41CPE112	41CPE112, 41CPE024, 41CPE012
	COMMUNICATION WITH THIRD-PARTY SW VIA MODBUS PROTOCOL				Yes	
	CONNECTIVITY			RS485		
	MAX. NUMBER OF EVAC PANELS IN THE NETWORK					5
	PROGRAMMING SW VERSION COMPATIBILITY					Software 5.3.15 or higher
	MAX. NUMBER OF DEVICES PER LOOP		250	250		
HARDWARE SPECIFICATIONS	WEIGHT (g)	30	30			
	OPERATING TEMPERATURE (°C)	-10 - 65	-10 - 65			
	CROSS-SECTION FOR TERMINALS (mm <sup>2</sup> )	0.4 - 2	0.4 - 2	0.5 - 2.5	0.2 - 1.5	
ELECTRICAL SPECIFICATIONS	POWER SUPPLY VOLTAGE				9-30 (24 VDC Rated)	
	RATED CURRENT ABSORPTION (STANDBY)				80 mA	
	MAXIMUM ABSORPTION (mA)	700	500		150	
	MAXIMUM DISTANCE (m)			1000		1000 (total)



FIRE ALARM ACCESSORIES		
		
	ITEM CODE	48FPT100
MAIN FEATURES	MODEL	Repetition indicator LED, LOGIFIRE series
ELECTRICAL SPECIFICATIONS	DIMENSIONS	48 (ø) x 32 (H) mm
	IP PROTECTION RATING	IP30
	MATERIAL	ABS
	COLOUR	White
	WEIGHT (g)	30
	VISUAL SIGNAL	Yes
	VISUAL INDICATION COLOUR	Red
	OPERATING TEMPERATURE (°C)	-10 - 60
OPERATING HUMIDITY (max % RH)	(93 ± 3)@40°C	
ELECTRICAL SPECIFICATIONS	POWER SUPPLY VOLTAGE	2.1 - 2.6 VDC
	MAXIMUM DIRECT CURRENT (mA)	50
	CONSUMPTION WITH ADDRESSED DETECTOR (mA)	5.2
	CONSUMPTION WITH CONVENTIONAL DETECTOR (mA)	5.5



# THE ADDRESSABLE RANGE



DETECTORS				
				
	ITEM CODE	<b>41RFU100</b>	<b>41RCS100</b>	<b>41RML100</b>
MAIN FEATURES	MODEL	Optical smoke detector, logifire series	Heat detector / rate of rise detector, logifire series	Multi-criteria smoke/heat detector + rate of rise detector, logifire series
	BACKWARDS COMPATIBLE WITH ATENA SERIES CONTROL PANELS	Yes	Yes	Yes
	SENSITIVITY LEVEL SETTINGS	High/Normal/Medium/Low	A1R (58°, RoR), A2S (60°), BS (75°)	High/Normal/Medium/Low (optics) - A1R (thermal - 58°, RoR)
	LED INDICATORS	2, 360° visibility	2, 360° visibility	2, 360° visibility
	DETECTOR CLASS (IN ACCORDANCE WITH A EN54-5)		A1/R, A2/S	A1/R
	ISOLATOR	Yes	Yes	Yes
	SETTLING TIME ON POWER-UP (s)	30	30	30
	CERTIFICATION STANDARD	EN54-7, EN54-17	EN54-5, EN54-17	EN54-5, EN54-7, EN54-17
HARDWARE SPECIFICATIONS	DIMENSIONS (ØxH - mm - BASE INCLUDED)	108 x 33	108 x 33	108 x 47
	IP PROTECTION RATING	IP30	IP30	IP30
	FINISH TYPE	ABS	ABS	ABS
	COLOUR	White	White	White
	WEIGHT (g)	125	125	125
	COMPATIBLE BASE	41RBX020	41RBX020	41RBX020
	OPERATING TEMPERATURE (°C)	-10 - 60	-10 - 60	-10 - 60
	OPERATING HUMIDITY (max % RH)	(93 ± 3)% @ 40°C	(93 ± 3)% @ 40°C	(93 ± 3)% @ 40°C
	CROSS-SECTION FOR TERMINALS (mm²)	0.4 - 2.5	0.4 - 2.5	0.4 - 2.5
ELECTRICAL SPECIFICATIONS	POWER SUPPLY	16 - 32 VDC (Rated 27 VDC)	16 - 32 VDC (Rated 27 VDC)	16 - 32 VDC (Rated 27 VDC)
	CURRENT CONSUMPTION IN COMMUNICATION	<310 µA@27 VDC	<290 µA@27 VDC	<310 µA@27 VDC
	RATED CURRENT ABSORPTION (STANDBY)	<190 µA@27 VDC	<170 µA@27 VDC	<190 µA@27 VDC
	ABSORPTION IN ALARM	6.5 mA	6.5 mA	6.5 mA
	OUTPUT IN ALARM STATE FOR REMOTE INDICATION	7.5 mA@7.5 VDC	7.5 mA@7.5 VDC	7.5 mA@7.5 VDC







FIRE ALARM PANEL ACCESSORIES			
			
		<b>41LTS000 / 41LTS000EN</b>	<b>41SPG000 / 41SPG000EN</b>
	ITEM CODE		
MAIN FEATURES	NUMBER OF ADDRESSES AVAILABLE		250
	LOOP SELF-DIAGNOSIS	Yes	
	DEVICE PARAMETER READING	Yes	
	AUTO-ADDRESSING FUNCTIONS	Yes	
	SEARCH FOR SHORT-CIRCUITS / BREAKS IN THE LOOP	Yes	
	DEVICE LED ACTIVATION	Yes	
	MULTI-LANGUAGE DISPLAY MENU	Yes	
HARDWARE CHARACTERISTICS	MATERIAL	ABS	ABS
	COLOUR	White	White
	WEIGHT (g)	250	260
	OPERATING TEMPERATURE (°C)	-5 - 40	-5 - 40
	OPERATING HUMIDITY (max % RH)	(93 ± 3)% @ 40°C	(93 ± 3)% @ 40°C
	CROSS-SECTION FOR TERMINALS (mm <sup>2</sup> )	0.2 - 2.5	
ELECTRICAL SPECIFICATIONS	POWER SUPPLY VOLTAGE	15 VDC	4.2- 8
	SECONDARY POWER SUPPLY		4 x 1.5 V batteries, type AA



# THE ADDRESSABLE RANGE

FIRE ALARM PANEL BUTTONS			
			
	ITEM CODE	<b>41PAM000</b>	<b>41PAE020</b>
MAIN FEATURES	TYPE OF DETECTION POINT	Manual alarm button	Manual alarm button
	ISOLATOR	Yes	Yes
	CERTIFICATION STANDARD	EN54-11, EN54-17	EN54-11, EN54-17
HARDWARE SPECIFICATIONS	DIMENSIONS	90 x 90 x 56	114x114x80
	IP PROTECTION RATING	IP40	IP67
	MATERIAL	ABS	ABS
	COLOUR	Red	Red
	WEIGHT	175	263
	FRAGILE ELEMENT TYPE	Resettable	Resettable
	OPERATING TEMPERATURE	-10 - 60	-10 - 60
	OPERATING HUMIDITY (MAX % RH)	(93 ± 3)% @ 40°C	(93 ± 3)% @ 40°C
CROSS-SECTION FOR TERMINALS (mm <sup>2</sup> )	0.4 - 2.0	0.4 - 2.5	
ELECTRICAL SPECIFICATIONS	POWER SUPPLY VOLTAGE	15 - 32	15 - 32
	CURRENT CONSUMPTION IN COMMUNICATION	160 uA@ 27 VDC	160 uA@ 27 VDC
	CURRENT CONSUMED IN ALARM STATUS	3	3





## SOUNDERS AND SIGNALLING UNITS

					
ITEM CODE		41SCI000	41SCB100	41SAI000	41SAB100
	MODEL		Base with sounder and strobe, logifire series		Base with sounder, logifire series
	BACKWARDS COMPATIBLE WITH ATENA SERIES CONTROL PANELS		Yes		Yes
	NUMBER OF TONES AVAILABLE	32	32	32	32
	OPTICAL SIGNAL COVERAGE IN ACCORDANCE WITH EN54-23	(W) 2.4 x 6			
	ISOLATOR	Yes	Yes	Yes	Yes
	CERTIFICATION STANDARD	EN54-3, EN54-17, EN54-23, UNI 11744:2019	EN54-3, EN54-17, UNI 11744:2019	EN54-3, EN54-17, UNI 11744:2019	EN54-3, EN54-17, UNI 11744:2019
HARDWARE SPECIFICATIONS	DIMENSIONS	116 (o) x 55 (H)		116 (ø) x 55 (H)	
	DIMENSIONS (ØxH - mm - BASE INCLUDED)		121 x 35		121 x 35
	IP PROTECTION RATING	IP43C	IP21C	IP43C	IP21C
	FINISH TYPE	ABS	Polycarbonate	ABS	ABS
	COLOUR	Red, white base	White	Red	White
	WEIGHT (g)	183	125	183	125
	VISUAL SIGNAL	Yes	Yes		
	VISUAL INDICATION COLOUR	White	Red		
	OPERATING TEMPERATURE (°C)	-10 - 50	-10 - 55	-10 - 50	-10 - 55
	OPERATING HUMIDITY (max % RH)	(93 ± 3)% @ 40°C	(93 ± 3)% @ 40°C	(93 ± 3)% @ 40°C	(93 ± 3)% @ 40°C
	COMPATIBLE BASE	41RBX020	41RBX020	41RBX020	41RBX020
	EFFECTIVE CABLE CROSS-SECTION (mm²)	0.4 - 2.5	0.4 - 2.5	0.4 - 2.5	0.4 - 2.5
ELECTRICAL SPECIFICATIONS	POWER SUPPLY VOLTAGE	15-32 (27 VDC Rated)	16 - 32 VDC (Rated 27 VDC)	15-32 (27 VDC Rated)	16 - 32 VDC (Rated 27 VDC)
	FLASHING FREQUENCY (Hz)	1	1		
	RATED CURRENT ABSORPTION (STANDBY)	500 uA/27 VDC	470 uA/27 VDC	500 uA/27 VDC	470 uA/27 VDC
	MAX. ABS. (OTHER TONES) HIGH VOLUME (WITH AUDIO AND STROBE ACTIVE)	<16.5 mA	10 mA @ 27 VDC		
	MAX. ABS. (OTHER TONES) HIGH VOLUME (WITH ONLY AUDIO ACTIVE)	<10 mA		<10 mA	9.8 mA @ 27 VDC
	MAX. ABS. (OTHER TONES) LOW VOLUME (WITH AUDIO AND STROBE ACTIVE)	<11 mA	3 mA @ 27 VDC		
	MAX. ABS. (OTHER TONES) LOW VOLUME (WITH ONLY AUDIO ACTIVE)	<4 mA		<4 mA	2.8 mA @ 27 VDC
	MAX. ABS. MAIN TONE 27 HIGH VOLUME WITH AUDIO AND STROBE ACTIVE	<22 mA	10 mA @ 27 VDC		
	MAX. ABS. MAIN TONE 27 HIGH VOLUME WITH ONLY AUDIO ACTIVE	<16.5 mA		<16.5 mA	9.8 mA @ 27 VDC
	MAX. ABS. MAIN TONE 27 LOW VOLUME WITH AUDIO + STROBE ACTIVE	<12 mA	3 mA @ 27 VDC		
	MAX. ABS. MAIN TONE 27 LOW VOLUME WITH ONLY AUDIO ACTIVE	<5 mA		<5 mA	2.8 mA @ 27 VDC
	SOUND POWER LEVEL (OTHER TONES) HIGH VOLUME (dB±3 dB@1 m)	80-95 dB±3 dB@1 m	81-97 dB ± 3 dB @ 1 m	80-95 dB±3 dB@1 m	81-97 dB ± 3 dB @ 1 m
	SOUND POWER LEVEL (OTHER TONES) LOW VOLUME (dB@1 m)	75-85 dB±3 dB@1 m	76-90 dB ± 3 dB @ 1 m	75-85 dB±3 dB@1 m	76-90 dB ± 3 dB @ 1 m
	SOUND POWER LEVEL (MAIN TONE 27) HIGH VOLUME (dB@1 m)	~ 92 dB±5 dB@1 m	~ 93.5 dB (A) ± 4 dB @ 1 m	92 dB±5 dB@1 m	~ 93.5 dB (A) ± 4 dB @ 1 m
	SOUND POWER LEVEL (MAIN TONE 27) LOW VOLUME (dB@1 m)	~ 80 dB±6 dB@1 m	~ 83.5 dB (A) ± 3 dB @ 1 m	80 dB±6 dB@1 m	~ 83.5 dB (A) ± 3 dB @ 1 m







# THE ADDRESSABLE RANGE

## FIRE ALARM MODULES

						
		<b>4110M022</b>	<b>4110M122</b>	<b>4110M040</b>	<b>4110M004</b>	<b>4110M000</b>
MAIN FEATURES	ISOLATOR	Yes	Yes	Yes	Yes	Yes
	CERTIFICATION STANDARD	EN54-17, EN54-18	EN54-17, EN54-18	EN54-17, EN54-18	EN54-17, EN54-18	EN54-17, EN54-18
HARDWARE SPECIFICATIONS	DIMENSIONS (L x H x D)	142x80x45	142x80x45	142x80x45	142x80x45	142x80x45
	IP PROTECTION RATING	IP21	IP21	IP21	IP21	IP21
	MATERIAL	ABS	ABS	ABS	ABS	ABS
	COLOUR	White, transparent cover	White, transparent cover	White, transparent cover	White, transparent cover	White, transparent cover
	WEIGHT (g)	230	230	230	230	230
	OPERATING TEMPERATURE (°C)	-10 - 60	-10 - 60	-10 - 60	-10 - 60	-10 - 60
	OPERATING HUMIDITY (max % RH)	(93 ± 3)% @ 40°C	(93 ± 3)% @ 40°C	(93 ± 3)% @ 40°C	(93 ± 3)% @ 40°C	(93 ± 3)% @ 40°C
	CABLE CROSS-SECTION (mm <sup>2</sup> )	0.4 - 2.5	0.4 - 2.5	0.4 - 2.5	0.4 - 2.5	0.4 - 2.5
ELECTRICAL SPECIFICATIONS	POWER SUPPLY VOLTAGE	15-32 VDC	15-32 VDC	15-32 VDC	15-32 VDC	15-32 VDC
	ABSORPTION IN STANDBY (mA)	0.24		0.27	0.18	0.27
	RATED POWER ABSORPTION	260 uA@27 VDC		330 uA@ 27 VDC	220 uA@27 VDC	270 uA@27 VDC
	ABSORPTION WITH 1 LED ON (mA)	3.5		4	4	3.6
	RATED ABSORPTION (RELAY OUTPUTS SELECTED)		<0.87 mA@27 VDC			
	ABSORPTION WITH 1 LED ON (RELAY OUTPUTS SELECTED)		3.9 mA			
	ABSORPTION WITH 2 LEDS ON (RELAY OUTPUTS SELECTED)		7.2 mA			
	RATED ABSORPTION (MONITORED OUTPUTS SELECTED)		<1.03 mA@27 VDC			
	ABSORPTION WITH 1 LED ON (MONITORED OUTPUTS SELECTED)		4.15 mA			
	ABSORPTION WITH 2 LEDS ON (MONITORED OUTPUTS SELECTED)		7.2 mA			
	MAX. ABS. WITH EXTERNAL POWER SUPPLY					
	MAX. ABS. WITH LOOP POWER SUPPLY (mA)					
	MAX. ABS. OF SENSORS IN ALARM MODE					
	OUTPUT/S MAXIMUM CURRENT	1 A@30 VDC/0.5 A@125 VAC	2 A@30 VDC / 0.5 A@125 Vac		1 A@30 VDC/0.5 A@125 VAC	0.75 A@28 VDC/0.5 A@120 VAC
	NUMBER OF SUPERVISED INPUTS	2	2	4		
	NUMBER OF RELAY OUTPUTS	2			4	
NO. OF RELAY OUTPUTS OR NO. OF MONITORED OUTPUTS		2			1	

NOTE: the XL versions of the products listed in the table only differ due to their different specifications: Dimensions (L x H x D): 176x126x57, IP rating: IP55, Material: PS, Colour: Grey



			
	<b>41IOM000/240</b>	<b>41ISC000</b>	<b>41IOM010</b>
	Yes	Yes	No
	EN54-17, EN54-18	EN54-17, EN54-18	
	142x80x45	142x80x45	43x25
	IP21	IP21	IP21C
	ABS	ABS	
	White, transparent cover	White, transparent cover	
	230	230	12
	-10 - 60	-10 - 60	-10 - 60
	(93 ± 3)% @ 40°C	(93 ± 3)% @ 40°C	(93 ± 3)% @ 40°C
	0.4 - 2.5	0.4 - 2.5	0.4 - 2.5
	15-32 VDC	15-32 VDC	15-32 VDC
	0.18		
	220 µA@27 VDC		100 uA@27 VDC
	4	3	
		150 µA@ 27 VDC	
		5.5	
		20 mA (zone powered by +L), 50 mA (zone powered by +H)	
	5 A@250 VAC/5 A@30 VDC		
	1		

FIRE ALARM MODULES		
	ITEM CODE	<b>41LED032</b>
		
MAIN FEATURES	MODEL	Synoptic panel on Loop, LOGIFIRE series
	COMPATIBLE CONTROL PANELS	41CPE118, 41CPE112
	INTERNAL BUZZER	Yes
	PROGRAMMING VIA PC	With programming software
	LOCAL PROGRAMMING	Yes, from control panel display
	ISOLATOR	Yes
	COMMANDS TO CONTROL PANEL 41CPE118	Inputs: Siren silencing, Buzzer silencing, Reset
	NUMBER OF PANEL STATUS OUTPUTS	4
	INDICATION TEST INPUT (LED AND BUZZER) 41LED032	Yes
	ENABLE COMMANDS (SILENCE SOUNDERS AND RESET)	Yes, via KeyLock input
	41LED032 FOR CONTROL PANEL (MAX.)	5 with 41CPE112, 50 with 41CPE118
	CERTIFICATION STANDARD	EN54-17, EN54-18
	HARDWARE SPECIFICATIONS	HEIGHT (mm)
WIDTH (mm)		225
DEPTH (mm)		80
IP PROTECTION RATING		IP55
MATERIAL		PS
COLOUR		Grey
WEIGHT (g)		750
OPERATING TEMPERATURE (°C)		-10 - 50
OPERATING HUMIDITY (max % RH)		(93 ± 3)% @ 40°C
CABLE CROSS-SECTION (mm²)	0.4 - 2.5	
ELECTRICAL SPECIFICATIONS	POWER SUPPLY VOLTAGE	12/24 Vdc
	NUMBER OF LED OUTPUTS (FREELY PROGRAMMABLE)	32
	NUMBER OF INPUT COMMANDS	5
	CONTROL PANEL STATUS INDICATION OUTPUTS	Power supply, Alarm, Exclusions, Fault
	ABSORPTION IN STANDBY (mA)	<2 @ 27 VDC
	ABSORPTION WITH STATUS LED ON (mA)	5.4
	OUTPUT POWER SUPPLY VOLTAGE	12-24 VDC (12 VDC for the LEDs)
	OUTPUTS TOTAL MAXIMUM CURRENT	390 mA@24 VDC / 790 mA@12 VDC
	MAX. LED CONNECTION CABLE LENGTH (m)	3



# THE CONVENTIONAL RANGE

## FIRE ALARM CONTROL PANELS

				
ITEM CODE		43CPC002EN	43CPC004EN	43CPC008EN
MAIN FEATURES	NUMBER OF DETECTION ZONES AVAILABLE	2	4	8
	COMELIT SENSORS AND MCP's PER ZONE (max)	32	32	32
	ZONE STATUS INDICATOR LEDs	Yes	Yes	Yes
	INTERNAL BUZZER	Yes	Yes	Yes
	LEVEL 2 PROTECTION	Mechanical key	Mechanical key	Mechanical key
	REMOTE PANEL CONTROL			Yes
	SOUNDER ACTIVATION DELAY			1 - 10 minutes
	DETECTION WITH CONFIRMATION (DUAL ACTION)			Yes
	INSTANTANEOUS ZONE			Programmable
	CERTIFICATION STANDARD	EN54-2, EN54-4	EN54-2, EN54-4	EN54-2, EN54-4
HARDWARE SPECIFICATIONS	NO. OF RELAYS WITH EXPANSION			8 (with art. 43ECR032)
	DIMENSIONS (L x H x D - mm)	340x290x100	340x290x100	340x290x100
	IP PROTECTION RATING	IP30	IP30	IP30
	ENCLOSURE	Plastic	Plastic	Plastic
	COLOUR	White	White	White
	WEIGHT WITHOUT BATTERIES (g)	2100	2100	2399.51
	OPERATING TEMPERATURE (°C)	-5 - 40	-5 - 40	-5 - 40
	OPERATING HUMIDITY (max % RH)	(93 ± 3)% @ 40°C	(93 ± 3)% @ 40°C	(93 ± 3)% @ 40°C
	STORAGE TEMPERATURE (°C)	-20 - 60	-20 - 60	-20 - 60
	MAX. CONNECTION CABLE CROSS-SECTION (mm <sup>2</sup> )	1 - 2.5	1 - 2.5	1 - 2.5
ELECTRICAL SPECIFICATIONS	MAIN POWER SUPPLY	230 VAC ±10% (0.3A fuse)	230 VAC ±10% (0.3A fuse)	230 VAC ±10% (0.3A fuse)
	BACKUP POWER SUPPLY (BATTERIES NOT SUPPLIED)	1x 12 VDC, 7 Ah, 2 A fuse	1x 12 VDC, 7 Ah, 2 A fuse	1x 12 VDC, 7 Ah, 2 A fuse
	AUXILIARY DEVICES POWER SUPPLY OUTPUT	24 (0.3A max)	24 (0.3A max)	24 (0.3A max)
	NETWORK POWER ABSORPTION (mA)	50	50	50
	MAX. POWER CONSUMPTION OF CONNECTED DEVICES WITH CHARGED BATTERY (A)	0.7	0.7	0.7
	FAULT RELAY AND ALARM RELAY OUTPUTS SWITCHING WITH VOLTAGE-FREE CONTACTS	3 A@120 VAC, 3 A@60 VDC	3 A@120 VAC, 3 A@60 VDC	3 A@120 VAC, 3 A@60 VDC
	MONITORED OUTPUTS	2 (0.3 A max. each)	2 (0.3 A max. each)	2 (0.3 A max. each)
	NO. OF FIRE RELAYS	1 (3A@120 Vac; 3A@60 VDC Max)	1 (3A@120 Vac; 3A@60 VDC Max)	1 (3A@24 VDC)
	NO. OF FAULT RELAYS	1 (3A@120 Vac; 3A@60 VDC Max)	1 (3A@120 Vac; 3A@60 VDC Max)	1 (3A@24 VDC)
	CIRCUIT OUTPUTS FOR SOUNDERS	24 VDC/0.3 A, 0.3 A fuse	24 VDC/0.3 A, 0.3 A fuse	0.5A@24 VDC, 0.5A fuse (PTC)
	OUTPUTS CIRCUIT FOR SOUNDERS 2	24 VDC/0.3 A, 0.3 A fuse	24 VDC/0.3 A, 0.3 A fuse	0.5A@24 VDC, 0.5A fuse (PTC)
	ALARM THRESHOLDS (mA)	10 - 110	10 - 110	10 - 110
	SHORT CIRCUIT ZONE THRESHOLDS	>110	>110	>110
	ZONE FAULT OR OPEN CIRCUIT THRESHOLDS (mA)	2	2	2
	NORMAL MODE ZONE THRESHOLDS (mA)	2 - 10	2 - 10	2 - 10



**43CPC016EN**

8 expandable to 16

32

Yes

Yes

Mechanical key

Yes

1 - 10 minutes

Yes

Programmable

EN54-2, EN54-4

8 (with art. 43ECR032)

441x331x80

IP30

Plastic

White

4000

-5 - 40

(93 ± 3)% @ 40°C

-20 - 60

1 - 2.5

230 VAC ±10% (0.3A fuse)

1x 12 VDC, 18 Ah, 4,5 A fuse

24 (0.3A max)

50

0.7

3 A@120 VAC, 3 A@60 VDC

2 (0.3 A max. each)

1 (3A@24 VDC)

1 (3A@24 VDC)

0.5A@24 VDC, 0.5A fuse (PTC)

0.5A@24 VDC, 0.5A fuse (PTC)

10 - 110

>110

2

2 - 10

**FIRE ALARM MODULES**



**ITEM CODE**

**43ECR032**

**HARDWARE SPECIFICATIONS**

**DIMENSIONS (L x H x D)**

130x111x41 mm

**WEIGHT (g)**

400

**OPERATING TEMPERATURE (°C)**

-5 - 40

**OPERATING HUMIDITY (max % RH)**

(93 ± 3)% @ 40°C

**CABLE CROSS-SECTION (mm²)**

1.5 - 2.5

**ELECTRICAL SPECIFICATIONS**

**NUMBER OF RELAY OUTPUTS**





8

**OUTPUTS MAXIMUM CURRENT**



1A@12 V or 0.5A@24 V



# THE CONVENTIONAL RANGE

DETECTORS						
						
	ITEM CODE	<b>43RFU100</b>	<b>43RCS100</b>	<b>43RCS101</b>	<b>43RCS102</b>	<b>43RML100</b>
MAIN FEATURES	TYPE OF DETECTION POINT	Optical smoke detector	Heat detector with fixed threshold 58°C + rate of rise detector	Heat detector with fixed threshold of 60°C	Heat detector with fixed threshold of 75°C	Multi-criteria smoke/heat detector + rate of rise detector
	SELF DIAGNOSIS	Yes	Yes	Yes	Yes	Yes
	LED INDICATORS	2, 360° visibility	2, 360° visibility	2, 360° visibility	2, 360° visibility	2, 360° visibility
	DETECTOR CLASS (IN ACCORDANCE WITH A EN54-5)		A1/R	A2/S	B/S	A1/R
	DRIFT COMPENSATION	Yes				
	SETTLING TIME ON POWER-UP (s)	30	30	30	30	30
	CERTIFICATION STANDARD	EN54-7	EN54-5	EN54-5	EN54-5	EN54-5, EN54-7
HARDWARE SPECIFICATIONS	DIMENSIONS (ØxH - mm - BASE INCLUDED)	102x42	102x42	102x42	102x42	102x42
	IP PROTECTION RATING	IP30	IP30	IP30	IP30	IP30
	COLOUR	White	White	White	White	White
	WEIGHT (g)	160	160	160	160	170
	OPERATING TEMPERATURE	-10 - 60	-10 - 60	-10 - 60	-10 - 60	-10 - 60
	OPERATING HUMIDITY (max % RH)	(93 ± 3)% @ 40°C	(93 ± 3)% @ 40°C	(93 ± 3)% @ 40°C	(93 ± 3)% @ 40°C	(93 ± 3)% @ 40°C
	CROSS-SECTION FOR TERMINALS (mm <sup>2</sup> )	0.4 - 2.5	0.4 - 2.5	0.4 - 2.5	0.4 - 2.5	0.4 - 2.5
ELECTRICAL SPECIFICATIONS	POWER SUPPLY	9 - 30 (12 - 24 VDC Rated)	9 - 30 (12 - 24 VDC Rated)	9 - 30 (12 - 24 VDC Rated)	9 - 30 (12 - 24 rated)	9 - 30 (12 - 24 rated)
	CURRENT ABSORPTION IN ALARM STATUS WITH BASES 43RBX000, 43RBX001 AND 43RBX005	20 mA, 12-30 VDC	20 mA, 12-30 VDC	20 mA, 12-30 VDC	20 mA, 12-30 VDC	20 mA, 12-30 VDC
	CURRENT ABSORPTION IN ALARM STATE WITH BASE TYPE 43RBX003	18 mA @ 9 VDC, 29 mA @ 12 VDC, 32 mA @ 15 VDC	18 mA @ 9 VDC, 29 mA @ 12 VDC, 32 mA @ 15 VDC	18 mA @ 9 VDC, 29 mA @ 12 VDC, 32 mA @ 15 VDC	18 mA @ 9 VDC, 29 mA @ 12 VDC, 32 mA @ 15 VDC	18 mA @ 9 VDC, 29 mA @ 12 VDC, 32 mA @ 15 VDC
	AVERAGE CURRENT CONSUMPTION IN INACTIVE STATE	<50 µA	<50 µA	<50 µA	<50 µA	<50 µA
	OUTPUT IN ALARM STATE FOR REMOTE INDICATION	20 mA/3.3 VDC	20 mA/3.3 VDC	20 mA/3.3 VDC	20 mA/3.3 VDC	20 mA/3.3 VDC





FIRE ALARM PANEL BUTTONS			
			
	ITEM CODE	<b>43PAM000</b>	<b>43PAE020</b>
MAIN FEATURES	TYPE OF DETECTION POINT	Manual alarm button	Manual alarm button
	CERTIFICATION STANDARD	EN54-11	EN54-11
HARDWARE SPECIFICATIONS	DIMENSIONS	90 x 90 x 56	114x114x80
	IP PROTECTION RATING	IP40	IP67
	MATERIAL	ABS	ABS
	COLOUR	Red	Red
	WEIGHT (g)	150	263
	FRAGILE ELEMENT TYPE	Resettable	Resettable
	OPERATING TEMPERATURE (°C)	-10 - 60	-10 - 60
	OPERATING HUMIDITY (max % RH)	(93 ± 3)% @ 40°C	(93 ± 3)% @ 40°C
ELECTRICAL SPECIFICATIONS	CROSS-SECTION FOR TERMINALS (mm <sup>2</sup> )	0.4 - 2.0	0.4 - 2.5
	POWER SUPPLY VOLTAGE	9 - 30 (12 - 24 rated)	9 - 30 (12 - 24 rated)
	CURRENT CONSUMED IN ALARM STATUS (mA)	23@15 V / 38@24 V / 48@30 V	23@15 V / 38@24 V / 48@30 V





FIRE ALARM ACCESSORIES		
		
	ITEM CODE	<b>48FPT100</b>
MAIN FEATURES	MODEL	Repetition indicator LED, LOGIFIRE series
HARDWARE SPECIFICATIONS	DIMENSIONS	48 (Ø) x 32 (H) mm
	IP PROTECTION RATING	IP30
	MATERIAL	ABS
	COLOUR	White
	WEIGHT (g)	30
	VISUAL SIGNAL	Yes
	VISUAL INDICATION COLOUR	Red
	OPERATING TEMPERATURE (°C)	-10 - 60
ELECTRICAL SPECIFICATIONS	OPERATING HUMIDITY (max % RH)	(93 ± 3)@40°C
	POWER SUPPLY VOLTAGE	2.1 - 2.6 VDC
	MAXIMUM DIRECT CURRENT (mA)	50
	CONSUMPTION WITH ADDRESSABLE DETECTOR (mA)	5.2
	CONSUMPTION WITH CONVENTIONAL DETECTOR (mA)	5.5



# THE SIGNALLING DEVICES RANGE

## SIGNALLING UNITS AND SOUNDERS





					
		<b>48SAE300</b>	<b>48CLU003</b>	<b>48SAE000</b>	
MAIN FEATURES	ITEM CODE	<b>48SAE300</b>	<b>48CLU003</b>	<b>48SAE000</b>	
	NUMBER OF TONES AVAILABLE	1	16	32	
	OPTICAL SIGNAL COVERAGE IN ACCORDANCE WITH EN54-23		(W) 3.6 x 9 m		
CERTIFICATION STANDARD		EN54-3	EN54-3, EN54-23, UNI 11744:2019	EN54-3, UNI 11744:2019	
HARDWARE SPECIFICATIONS	DIMENSIONS	230x310x60 mm (LxHxD)	275 x 135 x 50	95 (ø) x 92 (H)	
	IP PROTECTION RATING	IP44 (electronics part IP54)	IP21C	IP66 with fixing backplate art. 48SAE001	
	FINISH TYPE	ABS	ABS - V0 + Polycarbonate	ABS	
	COLOUR	Red	White	Red	
	WEIGHT (g)	1003			
	VISUAL SIGNAL	Yes	Yes		
	VISUAL INDICATION COLOUR	White	Red		
	OPERATING TEMPERATURE	-40 - 85	-10 - 55	-25 - 70	
	OPERATING HUMIDITY (max % RH)	(93 ± 3)@40°C	(93 ± 3)@40°C	(93 ± 3)@40°C	
	EFFECTIVE CABLE CROSS-SECTION (mm²)	0.28 - 2	0.4 - 2.5	0.28 - 2.5	
ELECTRICAL SPECIFICATIONS	POWER SUPPLY VOLTAGE (VDC)	20 - 30	19 - 30	9 - 30	
	SOUND FREQUENCY (Hz)	3100 - 3800			
	FLASHING FREQUENCY (Hz)				
	MAX. ABS. (OTHER TONES) HIGH VOLUME (WITH AUDIO AND STROBE ACTIVE)				
	MAX. ABS. (OTHER TONES) HIGH VOLUME (WITH ONLY AUDIO ACTIVE)				
	MAX. ABS. (OTHER TONES) LOW VOLUME (WITH AUDIO AND STROBE ACTIVE)				
	MAX. ABS. (OTHER TONES) LOW VOLUME (WITH ONLY AUDIO ACTIVE)				
	MAX. ABS. MAIN TONE 27 HIGH VOLUME WITH ONLY AUDIO ACTIVE				
	MAX. ABS. MAIN TONE 27 LOW VOLUME WITH ONLY AUDIO ACTIVE				
	MAX. ABS. (mA - OPTICAL PART/AUDIBLE PART)	28 mA @ 24 V	61	39	
	SOUND POWER LEVEL (OTHER TONES) HIGH VOLUME (dB@1 m)				
	SOUND POWER LEVEL (MAIN TONE 27) HIGH VOLUME (dB@1 m)				
	LOW LEVEL AUDIBLE INDICATION (dB@1 m)		71	94	
	HIGH LEVEL AUDIBLE INDICATION (dB@1 m)	95	91		







				
	<b>48SAI020</b>	<b>48SAI050</b>	<b>48SCI040</b>	<b>48SCI060</b>
	32	1	32	32
				(0) 2.3 / 1.5 / 0.75
	EN54-3, UNI 11744:2019	EN54-23	EN54-3, UNI 11744:2019	EN54-3, EN54-23, UNI 11744:2019
	102 (ø) x 32 (H)	69x94x45 (LxHxD)	102 (ø) x 32 (H)	102 (ø) x 32 (H)
	IP21C	IP21C	IP21C	IP21C
	ABS	ABS	SAN	SAN
	Red	Red	Transparent red	Transparent white
	248	77	248	248
		Yes	Yes	Yes
		Red	Red	White
	-10 - 60	-10 - +55	-10 - 60	-10 - 60
	(93 ± 3)@40°C	(93 ± 3)@40°C	(93 ± 3)@40°C	(93 ± 3)@40°C
	0.2 - 1.5	-0.2 - +1.5	0.4 - 1.5	0.2 - 1.5
	20 - 28	16 - 29	20 - 28	20 - 28
		2700 - 4000		
		2	1	1
			25 mA	25 mA
			22 mA	22 mA
			12 mA	12 mA
			8.5 mA	8.5 mA
	22 mA@24 VDC			
	8.5 mA@24 VDC			
		75		
	90-102 dB		83-102 dB	85-104 dB
	102 dB		92-101 dB	95-104 dB
	94		94	94
	102	100	102	102



# THE SIGNALLING DEVICES RANGE



## SIGNALLING UNITS AND SOUNDERS



					
ITEM CODE		48SCE000	48SCE020	48SCI000	48SCI020
MAIN FEATURES	NUMBER OF TONES AVAILABLE	32	32	32	32
	OPTICAL SIGNAL COVERAGE IN ACCORDANCE WITH EN54-23	(C) 3x15 m	(W) 3.1 x 11.3 m	(C) 3x15 m	(W) 3.1 x 11.3 m
	CERTIFICATION STANDARD	EN54-3, EN54-23, LPCB, UNI 11744:2019	EN54-3, EN54-23, LPCB, UNI 11744:2019	EN54-3, EN54-23, LPCB, UNI 11744:2019	EN54-3, EN54-23, LPCB, UNI 11744:2019
	NUMBER OF TONES AVAILABLE				
HARDWARE SPECIFICATIONS	DIMENSIONS	97.5 (ø) x 117 (H)	97.5 (ø) x 122 (H)	100 (ø) x 94 (H)	100 (ø) x 100 (H)
	IP PROTECTION RATING	IP65	IP65	IP21	IP21
	FINISH TYPE	High-resistance polycarbonate	High-resistance polycarbonate	High-resistance polycarbonate	High-resistance polycarbonate
	COLOUR	Red	Red	Red	Red
	WEIGHT (g)				
	VISUAL SIGNAL	Yes	Yes	Yes	Yes
	VISUAL INDICATION COLOUR	White	White	White	White
	OPERATING TEMPERATURE (°C)	-10 - 55	-10 - 55	-10 - 55	-10 - 55
	OPERATING HUMIDITY (max % RH)	<90	<90	<90	<90
	EFFECTIVE CABLE CROSS-SECTION (mm <sup>2</sup> )				
ELECTRICAL SPECIFICATIONS	POWER SUPPLY VOLTAGE (VDC)	17 - 60	17 - 60	17 - 60	17 - 60
	SOUND FREQUENCY (Hz)	440 - 2900	440 - 2900	440 - 2900	440 - 2900
	FLASHING FREQUENCY (Hz)	1	1	1	1
	MAX. ABS. (mA - OPTICAL PART/AUDIBLE PART)	25@0.5 Hz, 45@1 Hz	25@0.5 Hz, 45@1 Hz	25@0.5 Hz, 45@1 Hz	25@0.5 Hz, 45@1 Hz
	MAX. ABS. (OTHER TONES) HIGH VOLUME (WITH AUDIO AND STROBE ACTIVE)				
	MAX. ABS. (OTHER TONES) HIGH VOLUME (WITH ONLY AUDIO ACTIVE)				
	MAX. ABS. (OTHER TONES) LOW VOLUME (WITH AUDIO AND STROBE ACTIVE)				
	MAX. ABS. (OTHER TONES) LOW VOLUME (WITH ONLY AUDIO ACTIVE)				
	MAX. ABS. MAIN TONE 27 HIGH VOLUME WITH ONLY AUDIO ACTIVE				
	MAX. ABS. MAIN TONE 27 LOW VOLUME WITH ONLY AUDIO ACTIVE				
	MAX. ABS. (mA - OPTICAL PART/AUDIBLE PART)				
	FLASHING FREQUENCY (Hz)				
	LOW LEVEL AUDIBLE INDICATION (dB@1 m)				
	SOUND POWER LEVEL (OTHER TONES) HIGH VOLUME (dB@1 m)	97 dB	97 dB		
	SOUND POWER LEVEL (MAIN TONE 27) HIGH VOLUME (dB@1 m)				
	LOW LEVEL AUDIBLE INDICATION (dB@1 m)	94	94	94	94
	HIGH LEVEL AUDIBLE INDICATION (dB@1 m)				

					
<b>48LME000</b>	<b>48LME020</b>	<b>48LMI000</b>	<b>48LMI020</b>	<b>48CME000</b>	<b>48CMI000</b>
(C) 3x15 m	(W) 3.1 x 11.3 m	(C) 3x15 m	(W) 3.1 x 11.3 m		
EN54-23, LPCB	EN54-23, LPCB	EN54-23, LPCB	EN54-23, LPCB	EN54-3	EN54-3
				1	1
97.5 (ø) x 117 (H)	97.5 (ø) x 122 (H)	100 (ø) x 94 (H)	100 (ø) x 100 (H)	150 (ø) x 64 (H)	150 (ø) x 53 (H)
IP65	IP65	IP21	IP21	IP55	IP33C
High-resistance polycarbonate	High-resistance polycarbonate	High-resistance polycarbonate	High-resistance polycarbonate	Aluminium	Aluminium
Red	Red	Red	Red	Red	Red
				780	410
Yes	Yes	Yes	Yes		
White	White	White	White		
-25 - 70	-25 - 70	-25 - 70	-25 - 70	-10 - 50	-10 - 50
<90	<90	<90	<90	45 - 85	
				0.4 - 2.5	0.4 - 2.5
17 - 60	17 - 60	17 - 60	17 - 60	20.4 - 27.6	24
20@0.5 Hz, 40@1 Hz (@24 VDC, strobe only)	20@0.5 Hz, 40@1 Hz (@24 VDC, strobe only)	20@0.5 Hz, 40@1 Hz (@24 VDC, strobe only)	20@0.5 Hz, 40@1 Hz (@24 VDC, strobe only)	12 (audible part only)	11 (audible part only)
1	1	1	1	94	94
				100+5 dB	95 dB





# THE WIRELESS RANGE

FIRE ALARM MODULES			
			
	ITEM CODE	45TRS000	45RPT000
MAIN FEATURES	FREQUENCY BAND	868 - 870	868 - 870
	FREQUENCY CHANNELS	7	7
	TWO-WAY RADIO COMMUNICATION	Yes	Yes
	MODULATION	FSK	FSK
	RF RANGE (metres in open field conditions)	200	
	RF OUTPUT POWER		5 dBm (3 mW)
	NUMBER OF DEVICES THAT CAN BE MANAGED VIA RADIO	32	32
	MAX. NO. OF REPEATERS THAT CAN BE PROGRAMMED ON A SINGLE TRANSLATOR (mm)	7	7
	MAXIMUM NUMBER OF REPEATERS CONNECTED ONE AFTER THE OTHER	5	5
	MAXIMUM NUMBER OF REPEATERS CONNECTED TO A SINGLE REPEATER		3
CERTIFICATION STANDARD	EN54-18, EN54-25	EN54-18, EN54-25	
HARDWARE SPECIFICATIONS	DIMENSIONS (L x H x D)	120x160x51 mm	120x160x51 mm
	IP PROTECTION RATING	IP51C	IP51C
	COLOUR	White	White
	WEIGHT (g)	330	300
	OPERATING TEMPERATURE (°C)	-10 - 50	-10 - 50
ELECTRICAL SPECIFICATIONS	POWER SUPPLY VOLTAGE	9-30 VDC	9-30 VDC
	MAXIMUM CURRENT ABSORPTION	60 mA@12 VDC (Alarm)	30 mA@12 VDC
	MAXIMUM VOLTAGE ON THE SOUNDER LINE (VDC)	27	
	RF RANGE WITH DETECTION AND SOUND DEVICES (m)		200
	RF RANGE WITH OTHER REPEATERS OR TRANSLATORS - OPEN FIELD (m)		600



DETECTORS				
				
	ITEM CODE	<b>L-OP-SG</b>	<b>L-HT-SG</b>	<b>L-MC-SG</b>
MAIN FEATURES	TYPE OF DETECTION POINT	Optical smoke detector	Heat detector/rate of rise detector	Multi-criteria smoke/heat detector
	SELF DIAGNOSIS	Yes	Yes	Yes
	LED INDICATORS	2	2	2
	DETECTOR CLASS (IN ACCORDANCE WITH A EN54-5)		A1/R, B/S	A1/R, B/S
	ALARM TEMPERATURE, CLASS A1/R (°C)		58	58
	ALARM TEMPERATURE, CLASS B/S (°C)		78	78
	FREQUENCY BAND	868 - 870	868 - 870	868 - 870
	FREQUENCY CHANNELS	7	7	7
	TWO-WAY RADIO COMMUNICATION	Yes	Yes	Yes
	SUPERVISION INTERVAL	60	60	60
	MODULATION	FSK	FSK	FSK
	RF RANGE (metres in open field conditions)	200	200	200
CERTIFICATION STANDARD	EN54-7, EN54-25	EN54-5, EN54-25	EN54-5, EN54-7, EN54-25	
HARDWARE SPECIFICATIONS	DIMENSIONS (ØxH - mm - base included)	110x70	110x70	110x70
	IP PROTECTION RATING	IP40	IP40	IP40
	COLOUR	White	White	White
	WEIGHT (g)	190.51	190.51	190.51
	OPERATING TEMPERATURE (°C)	-10 - 55	-10 - 55	-10 - 55
	OPERATING HUMIDITY (max % RH)	(93 ± 3)% @ 40°C	(93 ± 3)% @ 40°C	(93 ± 3)% @ 40°C
ELECTRICAL SPECIFICATIONS	MAIN BATTERY	1 x CR123	1 x CR123	1 x CR123
	SECONDARY BATTERY	1 x CR123	1 x CR123	1 x CR123
	MAIN BATTERY LIFE (years)	8	8	8



# THE WIRELESS RANGE

FIRE ALARM ACCESSORIES			
			
	ITEM CODE	<b>45FPT000</b>	<b>SGCP200</b>
MAIN FEATURES	FREQUENCY BAND	868 - 870	868 - 870
	FREQUENCY CHANNELS	7	7
	TWO-WAY RADIO COMMUNICATION	Yes	Yes
	SUPERVISION INTERVAL	3 minutes (recommended)	
	MODULATION	FSK	FSK
	RF RANGE (metres in open field conditions)	200	150
	RF OUTPUT POWER	5 dBm (3 mW)	14 dBm (25 mW)
	CERTIFICATION STANDARD		EN54-11, EN54-25
HARDWARE SPECIFICATIONS	WIDTH (mm)	80	88
	HEIGHT (mm)	80	87
	DEPTH (mm)	27	61
	IP PROTECTION RATING	IP42	IP42
	MATERIAL	ABS	ABS
	WEIGHT (g)		160
	FRAGILE ELEMENT TYPE		Resettable
	VISUAL SIGNAL	Yes	Yes
	LIGHT INDICATION	Continuous	
	VISUAL INDICATION COLOUR	Red	
	OPERATING TEMPERATURE (°C)	-10 - 55	-10 - 55
	OPERATING HUMIDITY (max % RH)	95	95
ELECTRICAL SPECIFICATIONS	MAIN BATTERY	1 x CR123	1 x CR123
	SECONDARY BATTERY	1 x CR2032A (3 Vdc)	1 x CR123
	MAIN BATTERY LIFE (years)	5	10



SIGNALLING UNITS AND SOUNDERS				
				
	ITEM CODE	<b>45SAI020</b>	<b>45SCI000</b>	<b>SGRBS100/L</b>
MAIN FEATURES	NUMBER OF TONES AVAILABLE	32	32	32
	OPTICAL SIGNAL COVERAGE IN ACCORDANCE WITH EN54-23		(W) 2.5 x 7 m (122.5 m3)	
	TWO-WAY RADIO COMMUNICATION	Yes	Yes	Yes
	FREQUENCY BAND	868 - 870	868 - 870	868 - 870
	FREQUENCY CHANNELS	7	7	7
	MODULATION	FSK	FSK	FSK
	RF RANGE (metres in open field conditions)	200	200	200
	RF OUTPUT POWER			5 dBm (3 mW)
	SUPERVISION INTERVAL	60	60	
CERTIFICATION STANDARD	EN54-3	EN54-3, EN54-23	EN54-25, EN54-3	
HARDWARE SPECIFICATIONS	DIMENSIONS	130 (ø) x 185 (H)	130 (ø) x 192 (H)	
	DIMENSIONS (ØxH - mm - base included)			120x52
	IP PROTECTION RATING	IP65	IP65	IP21C
	COLOUR	Red	Red	
	WEIGHT (g)	350	380	149.69
	VISUAL SIGNAL		Yes	
	VISUAL INDICATION COLOUR		White	
	OPERATING TEMPERATURE (°C)	-25 - 55	-25 - 55	
OPERATING HUMIDITY (max % RH)	<85	<85	(93 ± 3)% @ 40°C	
ELECTRICAL SPECIFICATIONS	SOUND FREQUENCY (Hz)	440 - 2900	440 - 2900	
	FLASHING FREQUENCY (Hz)		0.5	
	ABSORPTION IN ALARM	50	260	75
	SOUND POWER LEVEL (OTHER TONES) HIGH VOLUME (DB@1 M)	100+5 dB	100+5 dB	70 - 95 dB
	MAIN BATTERY	2 x CR123 (module 45MOD000)	2 x CR123 (module 45MOD000)	1 x CR123
	SECONDARY BATTERY			1 x CR123
	MAIN BATTERY LIFE (years)	3	3	3





# THE EXTINGUISHING RANGE

## EXTINGUISHANT CONTROL PANEL





EXTINGUISHANT CONTROL PANEL		
		
	ITEM CODE	<b>46EST003</b>
MAIN FEATURES	EXTINGUISHING ZONES	2 (AND)
	FIRE ALARM ZONES	1
	MAX. NUMBER OF DEVICES PER ZONE	32
	EVENT LOG MODULE (optional)	Art.46LEP000
	MAXIMUM NUMBER OF EVENT LOGS	1000
	MECHANICAL KEY FOR MODE SELECTION	Yes
	MONITORED INPUT FOR MANUAL RELEASE	Yes
	MONITORED INPUT FOR PORT STATUS: LOCK/RELEASE	Yes
	MONITORED INPUT FOR MODE SELECTION	Yes
	MONITORED INPUT FOR ENABLING/DISABLING EXTINGUISHING	Yes
	MONITORED INPUT FOR LOW PRESSURE	Yes
	MONITORED INPUT FOR FLOW CONTROL	Yes
	OUTPUT FOR DISPLAYING PORT STATUS: LOCK/RELEASE	Yes
	OUTPUT FOR DISPLAYING EXTINGUISHING DISABLING	Yes
	OUTPUT FOR DISPLAYING LOW PRESSURE	Yes
OUTPUT FOR DISPLAYING MANUAL MODE	Yes	
CERTIFICATION STANDARD	EN54-2, EN54-4, EN12094-1	
HARDWARE SPECIFICATIONS	DIMENSIONS (L x H x D - mm)	324x314x82 mm
	IP PROTECTION RATING	IP30
	WEIGHT (g)	3200
	OPERATING TEMPERATURE (°C)	-5 - 40
	OPERATING HUMIDITY (max % RH)	(93 ± 3)% @ 40°C
	STORAGE TEMPERATURE (°C)	-10 - 60
ELECTRICAL SPECIFICATIONS	MAIN POWER SUPPLY	110-230 VAC ±10%
	FREQUENCY	47 - 60
	CURRENT CONSUMPTION	0.3@230 VAC / 0.7@110 VAC
	BACKUP BATTERIES (not included)	2 (12 VDC / 7 Ah)
	MAXIMUM CURRENT FOR CHARGING BATTERIES (A)	0.3
	AUXILIARY POWER SUPPLY OUTPUT	26 VDC / 1.5A
	MONITORED OUTPUTS FOR SIRENS	2 (24 VDC/0.3 A)
	MONITORED OUTPUTS FOR EXTINGUISHING	1 (24 VDC/1 A 5 min - 24 VDC/3 A 20 ms)
	NON-MONITORED RELAY OUTPUTS FOR ALARM INDICATION	2 (5-30 VDC / 1A)
NON-MONITORED RELAY OUTPUTS FOR FAULT INDICATION	1 (5-30 VDC / 1A)	

FIRE ALARM PANEL BUTTONS			
			
		<b>46PMA100</b>	<b>46PMS120</b>
MAIN FEATURES	ITEM CODE	<b>46PMA100</b>	<b>46PMS120</b>
	MODEL	Yellow extinguishing activator manual call point	Blue stop extinguishing manual call point
HARDWARE SPECIFICATIONS	DIMENSIONS WITH PROTECTIVE COVER (mm)	94x60x92	94x60x92
	IP PROTECTION RATING	IP40	IP40
	MATERIAL	ABS	ABS
	COLOUR	Yellow	Blue
	WEIGHT (g)	169	173
	PROTECTIVE COVER SUPPLIED	Yes	Yes
	FRAGILE ELEMENT TYPE	Resettable	
	OPERATING TEMPERATURE (°C)	-10 - 60	-10 - 60
	OPERATING HUMIDITY (max % RH)	(93 ± 3)% @ 40°C	(93 ± 3)% @ 40°C
CROSS-SECTION FOR TERMINALS (mm <sup>2</sup> )	0.4 - 2.0	0.4 - 2.0	
ELECTRICAL SPECIFICATIONS	POWER SUPPLY VOLTAGE	9-30 VDC	9-30 VDC
	CONTACT TYPE	Normally open (N.O.)	Switching (n.o. / n.c.)



# THE ASPIRATING RANGE



ASPIRATING DETECTOR				
				
ITEM CODE		IFT-P	ILS-1	ILS-2
MAIN FEATURES	DETECTION ELEMENTS	Single-zone laser detector with double thermal element	1 high-sensitivity point detector	2 high-sensitivity point detectors
	COVERAGE AREA (m <sup>2</sup> )	1600	1600	1600
	PIPE EXTERNAL DIAMETER (mm)	25	25	25
	PIPE INTERNAL DIAMETER (mm)	21	21	21
	PIPE NETWORK LENGTH	2 openings: 100 m each	1 opening: 100 m	2 openings: 100 m each
	SENSITIVITY	0.001-20% obs/m	0.06-6% obs/m	0.06-6% obs/m
	CLASS A SAMPLING HOLES	6 + 6	3	3 + 3
	CLASS B SAMPLING HOLES	18 + 18	6	6 + 6
	CLASS C SAMPLING HOLES	18 + 18	18	18 + 18
	FILTER	Replaceable double filter	Replaceable internal (external optional)	Replaceable internal (external optional)
	FLOW MONITORING	Thermal element twisted pair	Programmable (2 levels, high/low)	Programmable (2 levels, high/low)
	ASPIRATOR CONTROLLER	10 programmable speeds	10 programmable speeds	10 programmable speeds
	PROGRAMMING VIA SOFTWARE	Yes	Yes	Yes
CERTIFICATIONS	EN54-20 (VdS)	EN54-20 (VdS)	EN54-20 (VdS)	
HARDWARE CHARACTERISTICS	DIMENSIONS	254x180x165 mm	259x184x166 mm	259x184x166 mm
	IP PROTECTION RATING	IP65	IP65	IP65
	WEIGHT (g)	4200	2500	2500
	SAMPLED AIR TEMPERATURE (°C)	-20 - 60	-20 - 60	-20 - 60
	OPERATING TEMPERATURE (°C)	0 - 39	-10 - 50	-10 - 50
	OPERATING HUMIDITY % RH	10 - 95	10 - 95	10 - 95
ELECTRICAL SPECIFICATIONS	POWER SUPPLY VOLTAGE	24 VDC	24 VDC	24 VDC
	MAX. ABSORPTION (W)	30	7.2	7.2
	MAXIMUM CURRENT ABSORPTION (mA)	1200	300	300
	RELAYS	5 (Fault/Alert/Action/Fire x2, NC/NO, 1A@30 VDC)	3 (Fault/Action/Fire, NC/NO, 1A@30 VDC)	6 (Fault/Action/Fire, NC/NO, 1A@30 VDC)







# THE BEAM DETECTION RANGE



## LINEAR SMOKE DETECTORS

			
		<b>RK100-B</b>	<b>RK100-BS</b>
MAIN FEATURES	ITEM CODE	<b>RK100-B</b>	<b>RK100-BS</b>
	DETECTION TYPE	Clouding and Turbulence	Clouding
	BUILT-IN LASER POINTER	Yes	Yes
	LED INDICATORS	Red (alarm status), Blue (compensation limit, fault, beam broken or normal operation)	Red (alarm status), Blue (compensation limit, fault, beam broken or normal operation)
	OPTICAL RANGE (m)	25 - 120	25 - 120
	BEAM TYPE	Infrared with digital encoding	Infrared with digital encoding
	PROTECTED AREA DIMENSIONS	1600 m2 (standards EN54-14 / UNI 9795:2005)	1600 m2 (standards EN54-14 / UNI 9795:2005)
	DRIFT COMPENSATION	Yes	Yes
	POLARITY INVERSION PROTECTION	Yes	Yes
	ALARM LEVEL ADJUSTMENT	Yes, 4-position selector switch	Yes, 4-position selector switch
CERTIFICATION STANDARD	EN54-12	EN54-12	
CONFORMITY AND CERTIFICATIONS	N/A	N/A	
HARDWARE SPECIFICATIONS	DIMENSIONS (L x H x D - mm)	247 x 146 x 114	247 x 146 x 114
	IP PROTECTION RATING	IP65	IP65
	FINISH TYPE	Polycarbonate	Polycarbonate
	WEIGHT (g)	900	900
	OPERATING TEMPERATURE	-10 - 55	-10 - 55
	OPERATING HUMIDITY (max % RH)	(93 ± 3)% @ 40°C	(93 ± 3)% @ 40°C
	MAX. ANGULAR MISALIGNMENT OF THE OPTICAL PART (±, °)	0.2	0.2
CROSS-SECTION FOR TERMINALS (mm <sup>2</sup> )	0.2 - 1.5	0.2 - 1.5	
ELECTRICAL SPECIFICATIONS	POWER SUPPLY	12-24 VDC (-10% to +15%)	12-24 VDC (-10% to +15%)
	RX RECEIVER CONSUMPTION IN STANDBY (mA)	18.6	18.6
	RX RECEIVER CONSUMPTION (mA)	34 with alarm relay active; 50 with alarm and fault relays active	34 with alarm relay active; 50 with alarm and fault relays active
	TX TRANSMITTER CONSUMPTION (mA)	9.5	9.5
	NUMBER OF ALARM RELAY OUTPUTS	2, Clouding and Turbulence	1, Clouding
	NUMBER OF FAULT RELAY OUTPUTS	1	1
	ALARM RELAY TRIGGER DELAY (s)	10	10
	FAULT RELAY TRIGGER DELAY (s)	5	5
	RELAY CONTACT CAPACITY	1 A@24 VDC	1 A@24 VDC
ANALOGUE OUTPUT	0-5 V for measuring the signal level	0-5 V for measuring the signal level	

			
	<b>RK200-B</b>	<b>RK200-BS</b>	<b>RK100-BS-EX</b>
	Clouding and Turbulence	Clouding	Clouding
	Yes	Yes	Yes
	Red (alarm status), Blue (compensation limit, fault, beam broken or normal operation)	Red (alarm status), Blue (compensation limit, fault, beam broken or normal operation)	Red (alarm status), Blue (compensation limit, fault, beam broken or normal operation)
	40 - 200	40 - 200	25 - 120
	Infrared with digital encoding	Infrared with digital encoding	Infrared with digital encoding
	1600 m2 (standards EN54-14 / UNI 9795:2005)	1600 m2 (standards EN54-14 / UNI 9795:2005)	1600 m2 (standards EN54-14 / UNI 9795:2005)
	Yes	Yes	Yes
	Yes	Yes	Yes
	Yes, 4-position selector switch	Yes, 4-position selector switch	Yes, 4-position selector switch
	EN54-12	EN54-12	EN54-12
	N/A	N/A	ATEX - INERIS 13ATEX0057X IECEx INE13.0076X
	247 x 146 x 114	247 x 146 x 114	247 x 146 x 114
	IP65	IP65	IP66
	Polycarbonate	Polycarbonate	Light alloy in ATEX application
	900	900	8000
	-10 - 55	-10 - 55	-10 - 55
	(93 ± 3)% @ 40°C	(93 ± 3)% @ 40°C	(93 ± 3)% @ 40°C
	0.2	0.2	0.2
	0.2 - 1.5	0.2 - 1.5	0.2 - 1.5
	12-24 VDC (-10% to +15%)	12-24 VDC (-10% to +15%)	12-24 VDC (-10% to +15%)
	18.6	18.6	18.6
	34 with alarm relay active; 50 with alarm and fault relays active	34 with alarm relay active; 50 with alarm and fault relays active	34 with alarm relay active; 50 with alarm and fault relays active
	9.5	9.5	9.5
	2, Clouding and Turbulence	1, Clouding	1, Clouding
	1	1	1
	10	10	10
	5	5	5
	1 A@24 VDC	1 A@24 VDC	1 A@24 VDC
	0-5 V for measuring the signal level	0-5 V for measuring the signal level	0-5 V for measuring the signal level



# THE BEAM DETECTION RANGE

LINEAR SMOKE DETECTORS				
				
ITEM CODE		48BFC000	48BFC002	48BFC003
MAIN FEATURES	BUILT-IN LASER POINTER	Yes	Yes	Yes
	LED INDICATORS	1	1	1
	OPTICAL RANGE (m)	3 - 30	5 - 50	50 - 100
	PROTECTED AREA DIMENSIONS	1600 m2 (standards EN54-14 / UNI 9795:2005)	1600 m2 (standards EN54-14 / UNI 9795:2005)	1600 m2 (standards EN54-14 / UNI 9795:2005)
	POLARITY INVERSION PROTECTION	Yes	Yes	Yes
	CERTIFICATION STANDARD	EN54-12	EN54-12	EN54-12
HARDWARE SPECIFICATIONS	DIMENSIONS (L x H x D - mm)	115x115x78	128x80x84	128x80x84
	IP PROTECTION RATING	IP41	IP40	IP40
	FINISH TYPE	ABS	ABS	ABS
	COLOUR	White	White	White
	WEIGHT (g)	700	350	350
	OPERATING TEMPERATURE (°C)	-10 - 55	-25 - 55	-25 - 55
	OPERATING HUMIDITY (max % RH)	(93 ± 3)% @ 40°C	(93 ± 3)% @ 40°C	(93 ± 3)% @ 40°C
	WAVELENGTH (nm)	940		
	MAX. ANGULAR MISALIGNMENT OF THE OPTICAL PART (±, °)	0.35	0.5	0.5
	MAX.ANGULAR MISALIGNMENT OF THE REFLECTOR (±, °)	5	5	5
	MAX.ANGULAR MOVEMENT OF THE OPTICAL PART (±, °)	1.8		
	CROSS-SECTION FOR TERMINALS (mm <sup>2</sup> )	0.5 - 1.5	0.5 - 1.5	0.5 - 1.5
	ELECTRICAL SPECIFICATIONS	POWER SUPPLY	13 - 28	13 - 28
STANDBY CURRENT (@24 VDC - mA)		2.8	8 - 30	8 - 30
CURRENT IN ALARM STATUS (@24 VDC - mA)		12	20 - 100	20 - 100









# THE GAS DETECTION RANGE





GAS DETECTION CONTROL PANELS			
			
	ITEM CODE	<b>47CPG424</b>	<b>47CPG408</b>
MAIN FEATURES	DISPLAY	Yes	Yes
	MULTI-LANGUAGE DISPLAY MENU	Yes	Yes
	NUMBER OF KEYS ON THE BACKLIT KEYPAD	18	8
	SERIES OF CONNECTABLE SENSORS	Art.47RTSxxx, 47TS255CB	Art.47RTSxxx, 47TS255CB
	PRE-PROGRAMMED SENSORS	Yes	Yes
	INTERNAL BUZZER	Yes	Yes
	NUMBER OF PASSWORD-PROTECTED ACCESS LEVELS	3	3
	MAXIMUM NUMBER OF EVENT LOGS	100	100
	GAS LEVEL DISPLAY IN REAL TIME	Yes	Yes
	RESET FUNCTION	Yes	Yes
	FW UPDATING VIA SD CARD	Yes	Yes
	PROGRAMMING AND EVENT LOG BACKUP ON SD CARD	Yes	
	NUMBER OF SYSTEM STATUS LEDS	3	3
	NUMBER OF TRIGGER THRESHOLDS	3	3
	FAULT TRIGGER THRESHOLDS	Yes	Yes
	PROGRAMMABLE TRIGGER THRESHOLDS	Yes	Yes
PROGRAMMABLE ZONE TRIGGER THRESHOLDS	Yes	Yes	
AND/OR/PARKING OP. LOG. (D.M. 1/2/86 OR EN50545-1) USED BY ZONE	Yes	Yes	
HARDWARE CHARACTERISTICS	DIMENSIONS (L x H x D - mm)	379x241x133	379x241x133
	IP PROTECTION RATING	IP42	IP42
	FINISH TYPE	Plastic	Plastic
	DISPLAY BACKLIGHTING COLOUR	Colour	White
	WEIGHT (g)	2200	2200
	OPERATING TEMPERATURE (°C)	5 - 40	5 - 40
	OPERATING HUMIDITY (max % RH)	5 to 90% RH	5 to 90% RH
ELECTRICAL SPECIFICATIONS	POWER SUPPLY VOLTAGE	90-264 VAC / 47-63 Hz	90-264 VAC / 47-63 Hz
	BACKUP POWER SUPPLY (BATTERIES NOT SUPPLIED)	2 x 12 V 1.1 Ah (Art. 30076001)	2 x 12 V 1.1 Ah (Art. 30076001)
	NUMBER OF LINEAR INPUTS 4-20 mA	4 as standard, + 4 (with art. 47ESP040), + 16 (with 2 art. 47ESP080)	4 as standard, + 4 (with card art. 47ESP040)
	SENSOR INPUT POWER SUPPLY	24 VDC (-10% / +15%) / 100 mA	24 VDC (-10% / +15%) / 100 mA
	MAXIMUM CURRENT DELIVERED BY THE POWER SUPPLY UNIT	2.7 A@27.6 VDC	2.7 A@27.6 VDC
	NUMBER OF PROGRAMMABLE OUTPUTS	5 as standard, + 4 (with card art. 47REL040)	5 as standard, + 4 (with card art. 47REL040)
	RELAY CONTACT CAPACITY	3A@230 VAC, 2A@30 VDC	3A@230 VAC, 2A@30 VDC
	NUMBER OF INSTANT ALARM INPUTS (mm)	1	1
	INPUT CHARGE INTERNAL RESISTANCE (Ω)	100	100
	NUMBER OF PANEL-SENSOR CABLES	3	3
	MAXIMUM DETECTOR DISTANCE WITH SHIELDED CABLE 3X0.75 mm <sup>2</sup>	150	150
	MAXIMUM DETECTOR DISTANCE WITH SHIELDED CABLE 3X1.5 mm <sup>2</sup>	400	400
	MAXIMUM DETECTOR DISTANCE WITH SHIELDED CABLE 3X2.5 mm <sup>2</sup>	600	600

GAS DETECTION CONTROL PANELS		
		
	ITEM CODE	<b>47ESP080</b>
MAIN FEATURES	SERIES OF CONNECTABLE SENSORS	Art.47RTSxxx, 47TS255CB
	DATA TRANSMISSION WITH GAS DETECTION CONTROL PANEL	Via RS485
HARDWARE SPECIFICATIONS	DIMENSIONS (L x H x D - mm)	290x220x80
	FINISH TYPE	Plastic
	WEIGHT (g)	1400
	OPERATING TEMPERATURE (°C)	5 - 40
	OPERATING HUMIDITY (max % RH)	
ELECTRICAL SPECIFICATIONS	POWER SUPPLY VOLTAGE	230 VAC (-15% to +10%) / 50 Hz
	BACKUP POWER SUPPLY (BATTERIES NOT SUPPLIED)	1 x 12 VDC 2 Ah (Art. 20022204)
	NUMBER OF LINEAR INPUTS 4-20 mA	8
	SENSOR INPUT POWER SUPPLY	20 VDC (-10% to +15%)
	OPTIONAL BOARD RELAY CAPACITY	3A (resistive) / 1A (inductive) / 250 VAC
	INPUT CHARGE INTERNAL RESISTANCE (Ω)	200
	NUMBER OF PANEL-SENSOR CABLES	3
	MAXIMUM DETECTOR DISTANCE WITH SHIELDED CABLE 3X1.5 mm <sup>2</sup>	400
	MAXIMUM DETECTOR DISTANCE WITH SHIELDED CABLE 3X2.5 mm <sup>2</sup>	600





# THE GAS DETECTION RANGE



GAS DETECTION CONTROL PANELS		
		
	ITEM CODE	<b>47CDG206</b>
MAIN FEATURES	DISPLAY	Yes
	MULTI-LANGUAGE DISPLAY MENU	Yes
	NUMBER OF KEYS ON THE BACKLIT KEYPAD	4
	DIN RAIL MOUNTING	Yes
	NUMBER OF DIN MODULES	5
	SERIES OF CONNECTABLE SENSORS	Art.47RTSxxx, 47TS255CB
	PRE-PROGRAMMED SENSORS	Yes
	INTERNAL BUZZER	Yes
	NUMBER OF PASSWORD-PROTECTED ACCESS LEVELS	3
	GAS LEVEL DISPLAY IN REAL TIME	Yes
	NUMBER OF SYSTEM STATUS LEDS	3
	PROGRAMMABLE TRIGGER THRESHOLDS	Yes
HARDWARE CHARACTERISTICS	DIMENSIONS (L x H x D - mm)	90x60x71
	FINISH TYPE	Plastic
	DISPLAY BACKLIGHTING COLOUR	Amber
	WEIGHT (g)	195
	OPERATING TEMPERATURE (°C)	5 - 40
ELECTRICAL SPECIFICATIONS	POWER SUPPLY VOLTAGE	12-24 VDC (-10% to +15%)
	NUMBER OF LINEAR INPUTS 4-20 mA	2 as standard, + 4 (with card art. 47EDG020)
	SENSOR INPUT POWER SUPPLY	20 VDC (-10% to +15%)
	MAXIMUM ABSORPTION	15
	RELAY CONTACT CAPACITY	3A@230 VAC, 2A@30 VDC
	INPUT CHARGE INTERNAL RESISTANCE (Ω)	200
	NUMBER OF PANEL-SENSOR CABLES	3
	MAXIMUM DETECTOR DISTANCE WITH SHIELDED CABLE 3X1.5 mm <sup>2</sup>	300
	MAXIMUM DETECTOR DISTANCE WITH SHIELDED CABLE 3X2.5 mm <sup>2</sup>	600

GAS DETECTION CONTROL PANELS AND ACCESSORIES					
					
	ITEM CODE	<b>47EDG020</b>	<b>47ADG206</b>	<b>47BDL012</b>	<b>47ADB012</b>
MAIN FEATURES	DIN RAIL MOUNTING	Yes	Yes	Yes	Yes
	NUMBER OF DIN MODULES	2	3	3	3
	AUTONOMOUS OPERATION WITH FULL CONFIGURATION (min)			40	
	SERIES OF CONNECTABLE SENSORS	Art.47RTSxxx, 47TS255CB			
	PROGRAMMABLE ZONE TRIGGER THRESHOLDS	Yes			
HARDWARE CHARACTERISTICS	FINISH TYPE	Plastic	Plastic	Plastic	Plastic
	OPERATING TEMPERATURE (°C)	5 - 40	5 - 40		
ELECTRICAL SPECIFICATIONS	POWER SUPPLY VOLTAGE	230 Vac/12-24 Vac (-15% to +10%)/50 Hz/3 Va, 12-24 VDC (-10% to +15%)/1.5 W	230 (-15%/+10%) / 50 Hz		230 (-15%/+10%) / 50 Hz
	NUMBER OF LINEAR INPUTS 4-20 mA	2			
	NUMBER OF EXPANSION-SENSOR CABLES	3			
	NUMBER OF EXPANSION-PANEL ART. 47CDG206 CABLES	4			
	OUTPUT VOLTAGE			10.8 VDC	12 VDC
	CAPACITY (Ah)			1.7	



# THE GAS DETECTION RANGE





GAS DETECTION CONTROL PANELS			
			
	ITEM CODE	<b>47CMZ001</b>	<b>47CPZ003</b>
MAIN FEATURES	SERIES OF CONNECTABLE SENSORS	Art.47SE192KM, 47SE192KG	Art.47SE192KM, 47SE192KG
	GAS LEVEL DISPLAY IN REAL TIME	Yes	Yes
	RESET FUNCTION	Yes	Yes
	NUMBER OF TRIGGER THRESHOLDS	2	2
	ALARM TRIGGER THRESHOLD 1	10% LEL	10% LEL
	ALARM TRIGGER THRESHOLD 2	20% LEL	20% LEL
HARDWARE SPECIFICATIONS	DIMENSIONS (L x H x D - mm)	202x153x104	202x153x104
	IP PROTECTION RATING	IP65	IP65
	FINISH TYPE	Plastic	Plastic
	WEIGHT (g)	700	700
	OPERATING TEMPERATURE (°C)	-10 - 50	-10 - 50
	OPERATING HUMIDITY (max % RH)	5 to 90% RH	5 to 90% RH
ELECTRICAL SPECIFICATIONS	POWER SUPPLY VOLTAGE	230 Vac/12-24 Vac (-15% to +10%)/50 Hz/3 Va, 12-24 VDC (-10% to +15%)/1.5 W	230 Vac (-15% to +10%)/50 Hz/8 Va, 24 VDC (-10% to +15%)/9 W
	NUMBER OF LINEAR INPUTS 4-20 mA	1	3
	RELAY CONTACT CAPACITY	3A@230 VAC, 2A@30 VDC	3A@230 VAC, 2A@30 VDC
	NO. OF AUX INPUTS FOR SOLENOID VALVE WITH MAGNETIC SENSOR	1	1
	NUMBER OF PANEL-SENSOR CABLES	3	3
	MAXIMUM DETECTOR DISTANCE WITH SHIELDED CABLE 3X1.5 mm <sup>2</sup>	100	100
	MAXIMUM DETECTOR DISTANCE WITH SHIELDED CABLE 3X2.5 mm <sup>2</sup>	200	200

GAS DETECTORS			
			
	ITEM CODE	<b>47SE192KM</b>	<b>47SE192KG</b>
MAIN FEATURES	TYPE OF GAS DETECTED	METHANE	LPG
	SENSOR TYPE	Catalytic	Catalytic
	AVERAGE CARTRIDGE LIFE (years - clean air)	5	5
	INSTALLATION HEIGHT (m)	1.6	0.3
HARDWARE SPECIFICATIONS	DIMENSIONS (L x H x D - mm)	82x112x70	82x112x70
	IP RATING	IP44	IP44
	OPERATING HUMIDITY (RH - % - non-condensing)	5 - 90	5 - 90
	STORAGE TEMPERATURE (°C)	-25 - 55	-25 - 55
	STORAGE HUMIDITY (RH - % - non-condensing)	5 - 95	5 - 95
	MAXIMUM STORAGE TIME (MONTHS)	18	18
ELECTRICAL SPECIFICATIONS	POWER SUPPLY	12-24 VDC (-10% to +15%)	12-24 VDC (-10% to +15%)
	CONSUMPTION (W)	1	1
	NUMBER OF OUTPUTS 4-20 mA LINEAR	1	1
	FIELD OF MEASUREMENT (% LEL)	0 - 20	0 - 20
	SENSOR OPERATING LIMIT (% LEL)	50	50
	MAXIMUM LONG-TERM DRIFT (%/month)	0.4	0.4
	MAXIMUM RESPONSE TIME (T90 - s.)	30	30







# THE GAS DETECTION RANGE

## GAS DETECTORS



					
ITEM CODE		47TS255CB	47RTS282KM	47RTS282KG	47RTS282KI
MAIN FEATURES	TYPE OF GAS DETECTED	Carbon monoxide (CO), gasoline vapours	Methane	LPG	Hydrogen
	SENSOR TYPE	Electrochemical, Catalytic	Catalytic	Catalytic	Catalytic
	INTERCHANGEABLE CARTRIDGE	Yes	Yes	Yes	Yes
	AVERAGE CARTRIDGE LIFE (years - clean air)	5	5	5	5
	INSTALLATION HEIGHT (m)	1.6		0.3	
	INSTALLATION HEIGHT (cm from the ceiling)		30		30
	KEYS FOR CALIBRATION AND CHECKING WITH CODE	2	2	2	2
	ALARM LEVEL PROGRAMMING WITH DIP-SWITCHES		Yes	Yes	Yes
HARDWARE CHARACTERISTICS	DIMENSIONS (L x H x D - mm)	166.5x175x70	238x106x75	238x106x75	238x106x75
	IP PROTECTION RATING (°C)	IP65	IP65	IP65	IP65
	NUMBER OF STATUS LEADS	5	5	5	5
	OPERATING HUMIDITY (RH - % - non-condensing)	15 - 90	10 - 90	10 - 90	10 - 90
	STORAGE TEMPERATURE	-25 - 55	-20 - 55	-20 - 55	-20 - 55
	STORAGE HUMIDITY (RH - % - non-condensing)	5 - 95	5 - 95	5 - 95	5 - 95
	MAXIMUM STORAGE TIME (months)	3			
ELECTRICAL SPECIFICATIONS	POWER SUPPLY	12-24 VDC (-10% to +15%)	12-24 VDC (-10% to +15%)	12-24 VDC (-10% to +15%)	12-24 VDC (-10% to +15%)
	CONSUMPTION (W)	3	3	3	3
	NUMBER OF OUTPUTS 4-20 mA LINEAR	2	1	1	1
	NUMBER OF ALARM RELAY OUTPUTS		3	3	3
	NUMBER OF FAULT RELAY OUTPUTS		1	1	1
	RELAY CONTACT CAPACITY		1 A@24 VDC	1 A@24 VDC	1 A@24 VDC
	MEASUREMENT RANGE (parts per million)	0 - 300			
	FIELD OF MEASUREMENT (% LEL)	0 - 20	0 - 20	0 - 20	0 - 20
	DETECTION ACCURACY	± 10%	± 10%	± 10%	± 10%
	SENSOR OPERATING LIMIT (parts per million)	1500			
	SENSOR OPERATING LIMIT (% LEL)	30			
	MAXIMUM LONG-TERM DRIFT (%/month)	0.4			
	MAXIMUM LONG-TERM DRIFT (%/year)	5	4	4	4
	MAXIMUM RESPONSE TIME (T90 - s.)	60	60	60	60
	LOAD RESISTANCE	50Ω@12 VDC (-10%) / 500Ω@24 VDC (-10%)			
AUDIO SIGNALLING LEVEL (dB[a]@1 m)					





					
	<b>47RTS282KB</b>	<b>47RTS282EO</b>	<b>47RTS282EC-S</b>	<b>47RFM000</b>	<b>47RFG000</b>
	Gasoline vapours	Oxygen	Carbon monoxide (CO)	Methane	LPG
	Catalytic	Electrochemical	Electrochemical	Catalytic	Catalytic
	Yes	Yes	Yes		
	5	2	3	4	4
	0.4	1.6	1.6	1.6	0.3
	2	2	2		
	Yes	Yes	Yes		
	238x106x75	238x106x75	238x106x75	86x140x43	86x140x43
	IP65	IP65	IP65	IP42	IP42
	5	5	5	3	3
	10 - 90	15 - 90	15 - 90	30 - 90	30 - 90
	-20 - 55	0 - 20	0 - 20	-10 - 40	-10 - 40
	5 - 95	5 - 95	5 - 95	5 - 95	5 - 95
		3	3		
	12-24 VDC (-10% to +15%)	12-24 VDC (-10% to +15%)	12-24 VDC (-10% to +15%)		
	3	2	2	4	
	1	1	1		
	3	3	3	1	1
	1	1	1		
	1 A@24 VDC	1 A@24 VDC	1 A@24 VDC		
			0 - 300		
	0 - 20	0 - 25			
	± 10%	± 2%	± 10%		
			1000		
		30			
		2	2		
	4				
	60	20	60		
			50Ω@12 VDC (-10%) / 500Ω@24 VDC (-10%)		
				85	85



# THE ATEX RANGE

FIRE ALARM MODULES			
			
	ITEM CODE	<b>48BAZ000</b>	<b>48BAZ001</b>
MAIN FEATURES	DIN RAIL MOUNTING	Yes	Yes
	CERTIFICATION STANDARD	CE 0081 II (1/2) G [Eex ia/ib] IIC/IIB/PTB 01 ATEX 2088	CE 0359 II (1) GD [Eex ia] IIC/BAS 01 ATEX 7005
HARDWARE SPECIFICATIONS	HEIGHT (mm)	104	70
	WIDTH (mm)	70	80
	DEPTH (mm)	12.2	10
	IP PROTECTION RATING	IP20	IP20
	MATERIAL	Polyamide 6GF	Polycarbonate
	WEIGHT (g)	110	200
	OPERATING TEMPERATURE (°C)	-20 - 60	-20 - 60
ELECTRICAL SPECIFICATIONS	CABLE CROSS-SECTION (mm <sup>2</sup> )	0.5 - 2.5	0.5 - 2.5
	POWER SUPPLY VOLTAGE	24	15 - 28



HEAT/SMOKE DETECTORS			
			
	ITEM CODE	<b>48RCX000</b>	<b>48RFX000</b>
MAIN FEATURES	TYPE OF DETECTION POINT	Heat detector/rate of rise detector	Optical smoke detector
	LED INDICATORS	1	1
	CERTIFICATION STANDARD	CE 0081 II (1) G [Eex ia] IIC T6/LCIE 03 ATEX 6350 X	EN54-7
HARDWARE SPECIFICATIONS	DIMENSIONS (ØxH - mm - base included)	104x55	104x55
	IP PROTECTION RATING	IP32	IP32
	FINISH TYPE	ATEX ABS	ATEX ABS
	COLOUR	White	White
	WEIGHT (g)	110	130
	OPERATING TEMPERATURE (°C)	-20 - 55	-20 - 55
	OPERATING HUMIDITY (max % RH)	(93 ± 3)% @ 40°C	(93 ± 3)% @ 40°C
	STORAGE TEMPERATURE (°C)	10 - 50	10 - 50
ELECTRICAL SPECIFICATIONS	CROSS-SECTION FOR TERMINALS (mm <sup>2</sup> )	0.5 - 2.5	0.5 - 2.5
	POWER SUPPLY	10 - 28 VDC	10 - 28 VDC
	RATED CURRENT ABSORPTION (STANDBY)	<150 µA@20 VDC	<150 µA@20 VDC
	ABSORPTION IN ALARM	24 ± 2	24 ± 2



FIRE ALARM SOUNDER		
		
	ITEM CODE	<b>48SAX000</b>
MAIN FEATURES	NUMBER OF TONES AVAILABLE	49
	CERTIFICATION STANDARD	CE 0359 II (1) G [Ex ia] IIC T4/BAS 00 ATEX 1181
HARDWARE SPECIFICATIONS	DIMENSIONS	130 x 130 x 133.5
	IP PROTECTION RATING	IP66
	FINISH TYPE	ABS
	COLOUR	Red
	WEIGHT (g)	750
	OPERATING TEMPERATURE (°C)	-40 - 60
	OPERATING HUMIDITY (max % RH)	90@20°C
ELECTRICAL SPECIFICATIONS	EFFECTIVE CABLE CROSS-SECTION (mm²)	0.5 - 2.5
	POWER SUPPLY VOLTAGE	16 - 28
	LOW LEVEL AUDIBLE INDICATION (dB@1 m)	96
	HIGH LEVEL AUDIBLE INDICATION (dB@1 m)	105



FIRE ALARM BUTTONS		
		
	ITEM CODE	<b>48PAX000</b>
MAIN FEATURES	CERTIFICATION STANDARD	CE 0359 II (1) G [Ex ia] IIC T4/BAS 00 ATEX 1067
HARDWARE SPECIFICATIONS	WIDTH (mm)	98
	HEIGHT (mm)	98
	DEPTH (mm)	50.4
	IP PROTECTION RATING	IP33
	MATERIAL	ATEX ABS
	WEIGHT (g)	160
	FRAGILE ELEMENT TYPE	Resettable
	OPERATING TEMPERATURE (°C)	-20 - 55
ELECTRICAL SPECIFICATIONS	CROSS-SECTION FOR TERMINALS (mm²)	0.5 - 2.5
	POWER SUPPLY VOLTAGE	13-28 (20 VDC Rated)







# THE RANGE OF COMMON ACCESSORIES

FIRE ALARM POWER SUPPLY UNITS			
			
	ITEM CODE	<b>ZSP100-2.5A-18</b>	<b>ZSP100-5.5A-18</b>
MAIN FEATURES	SURFACE-MOUNTING	Yes	Yes
	VISUAL INDICATIONS	Yes	Yes
	CERTIFICATION STANDARD	EN54-4	EN54-4
HARDWARE SPECIFICATIONS	HEIGHT (mm)	356	356
	WIDTH (mm)	395	395
	DEPTH (mm)	96	96
	IP PROTECTION RATING	IP44	IP44
	NET WEIGHT (g)	4200	4200
	OPERATING TEMPERATURE (°C)	-25 - 55	-25 - 55
ELECTRICAL SPECIFICATIONS	POWER SUPPLY	110-230 VAC (± 10%)	110-230 VAC (± 10%)
	FREQUENCY	50 (± 10%)	50 (± 10%)
	RATED OUTPUT VOLTAGE (VDC)	27.1	27.1
	OUTPUT VOLTAGE RANGE (VDC)	20 - 28	20 - 28
	MAXIMUM ABSORPTION WITH CHARGED BATTERIES (W)	1.7	1.7
	MAXIMUM BATTERY CURRENT ABSORPTION (mA)	35	35
	MAXIMUM OUTPUT CURRENT WHEN CHARGING	1.7A	4.7A
	NO. AND TYPE OF BATTERIES	2 x 12 V/18 Ah	2 x 12 V/18 Ah
	NO. OF FAULT INDICATION INPUTS	1	1
	FAULT INDICATIONS	1 fault relay + 1 network status relay (voltage-free contact)	1 fault relay + 1 network status relay (voltage-free contact)

LINEAR HEAT CABLES			
			
	ITEM CODE	<b>48CTR068</b>	<b>48CTR105</b>
MAIN FEATURES	CABLE TYPE	Thermal non-resettable 68°C	Thermal non-resettable 105°C
	WIRES	Copper cable, Ø 0.95 mm	Copper cable, Ø 0.95 mm
	SHEATH INSULATION	Extruded thermoplastic sensitive to high temperatures	Extruded PVC 105°C sensitive to high temperatures
	ALARM TEMPERATURE RANGE (°C)	54 - 70	99 - 105
HARDWARE SPECIFICATIONS	CABLE DIMENSIONS (mm)	4.3	4.5
	COLOUR	Red	Black
	UNIT WEIGHT (kg / km)	25	26
	MAX. OPERATING TEMPERATURE (°C)	40	60
ELECTRICAL SPECIFICATIONS	MAX. STORAGE TEMPERATURE (°C)	40	40
	RATED VOLTAGE (V)	100	100
	RESISTANCE OF THE WIRES @ 20°C	≤ 290 Ω/km	≤ 290 Ω/km



APPROVED TELEPHONE DIALLERS			
			
	ITEM CODE	<b>CT440EN</b>	<b>CT400EN</b>
MAIN FEATURES	MULTI-LANGUAGE DISPLAY MENU	Yes	Yes
	CAN COMMUNICATE WITH ALARM RECEIPT CONTROL PANEL (ARC)	IRIS Secure Apps or IRIS Management Suite	IRIS Secure Apps or IRIS Management Suite
	ALARM PROTOCOLS	SIA (levels 0 to 3); Contact ID; Scancor Fats Format; Tellim; Robofon	SIA (levels 0 to 3); Contact ID; Scancor Fats Format; Tellim; Robofon
	ANTENNA CONNECTION	SMA port	SMA port
	SMS MANAGEMENT	Yes	Yes
	CERTIFICATION STANDARD	EN54-21 CPR; EN50131-1:2006; EN50136-1:2012/-2:2013 (grade 4); VDS; INCERT	EN54-21 CPR; EN50131-1:2006; EN50136-1:2012/-2:2013 (grade 4); VDS; INCERT
HARDWARE SPECIFICATIONS	BOARD DIMENSIONS	150 x 110 mm	150 x 110 mm
	PLASTIC BOX DIMENSIONS (LxHxD)	307 x 257 x 90 mm	307 x 257 x 90 mm
	COLOUR	White	White
	TOUCH SCREEN DISPLAY	Yes	Yes
	ETHERNET PORTS	2	2
	OPERATING TEMPERATURE (°C)	-10 - 55	-10 - 55
	OPERATING HUMIDITY (max % RH)	(93 ± 3)% @ 40°C	(93 ± 3)% @ 40°C
ELECTRICAL SPECIFICATIONS	POWER SUPPLY VOLTAGE	9-28 VDC	9-28 VDC
	RATED POWER ABSORPTION	153 mA	151 mA
	NUMBER OF RELAY OUTPUTS	4	4
	INPUT PINS	4	4
	PIN INPUT VOLTAGE	0 V - 12 VDC	0 V - 12 VDC
	PIN INPUT ALARM / RESET VOLTAGE	<1 V (alarm) / >2 V (reset)	<1 V (alarm) / >2 V (reset)
	RELAY OUTPUTS	100 mA @ 24 VDC Max.	100 mA @ 24 VDC Max.





ELECTROMAGNETIC DOOR HOLDERS					
					
	ITEM CODE	<b>48FME051</b>	<b>48FME052</b>	<b>48FME053</b>	<b>48FME101</b>
MAIN FEATURES	BACKPLATE LENGTH (mm)		150	300	300
	CERTIFICATIONS	EN1155	EN1155	EN1155	EN1155
ELECTRICAL SPECIFICATIONS	POWER SUPPLY VOLTAGE	24 VDC	24 VDC	24 VDC	24 VDC
	POWER (max/min W)	0.6 - 1.44	0 - 1.44	0 - 1.44	1.2 - 2.4
	ABSORPTION (mA)	25 - 60	0 - 60	0 - 60	50 - 100
	RETAINING FORCE (max/min)	0 - 50	0 - 50	0 - 50	50 - 100



# THE RANGE OF EVAC ACCESSORIES

## EVAC CONTROL PANELS



				
ITEM CODE		49CC0002	49CC0004	49CC0006
MAIN FEATURES	NUMBER OF AUDIO ZONES	2	4	6
	NUMBER OF AMPLIFIERS	2	4	6
	BACKUP AMPLIFIER (RESERVE)	Yes	Yes	Yes
	OPERATING CONFIGURATIONS FOR BACKUP AMPLIFIER	Zone 1	Zone 1, 2, 3	Zone 1, 2, 3, 4, 5
	LOUDSPEAKER LINE FOR EACH ZONE A AND B (LINE REDUNDANCY)	Yes	Yes	Yes
	MAX. NUMBER OF COMPACT PANELS CONNECTED TO EACH OTHER FOR A SYSTEM	6	6	6
	DUAL RJ45 SOCKET FOR LINK CONNECTION BETWEEN COMPACT PANELS	Yes	Yes	Yes
	RJ45 SOCKET FOR LINK CONNECTION BETWEEN FIRE ALARM PANELS	Yes	Yes	Yes
	FRONT INPUT FOR EMERGENCY MICROPHONE	Yes	Yes	Yes
	CONNECTION OF MICROPHONE STATIONS WITH RJ45 CONNECTION	Yes	Yes	Yes
	CONNECTION OF EMERGENCY STATIONS WITH RJ45 CONNECTION	Yes	Yes	Yes
	PROGRAMMABLE BALANCED AUXILIARY LINE (LINE-VOX)	Yes	Yes	Yes
	BALANCED MUSIC INPUT LINE	Yes	Yes	Yes
	CERTIFICATION STANDARD	EN54-4, EN54-16	EN54-4, EN54-16	EN54-4, EN54-16
HARDWARE SPECIFICATIONS	HEIGHT (mm)	620	620	620
	WIDTH (mm)	430	430	430
	DEPTH (mm)	240	240	240
	IP PROTECTION RATING	IP30	IP30	IP30
	ENCLOSURE	Metal	Metal	Metal
	BACKLIT DISPLAY WITH TOUCHSCREEN (inches)	4.3	4.3	4.3
	DISPLAY RESOLUTION (pixels)	480x272	480x272	480x272
	OPERATING TEMPERATURE (°C)	5 - 40	5 - 40	5 - 40
	OPERATING HUMIDITY (max % RH)	25 - 75	25 - 75	25 - 75
WALL-MOUNTED INSTALLATION	Yes	Yes	Yes	
ELECTRICAL SPECIFICATIONS	POWER SUPPLY VOLTAGE	230 VAC / 50-60 Hz (+10% / -15%)	230 VAC / 50-60 Hz (+10% / -15%)	230 VAC / 50-60 Hz (+10% / -15%)
	MAXIMUM TOTAL AUDIO POWER (W)	500	500	500
	MAXIMUM AUDIO POWER PER INDIVIDUAL AUDIO ZONE (W)	250	250	250
	MAXIMUM ABSORPTION (W)	646	653	660
	ABSORPTION IN STANDBY WHEN EMPTY (W)	36	46	50
	MAX ABSORPTION FOR SECONDARY POWER SUPPLY 24 VDC (A)	20	20	20
	MAX. BATTERY HOUSING	2x40 Ah	2x40 Ah	2x40 Ah
	PROGRAMMABLE SUPERVISED INPUTS	7	7	7
	RELAY OUTPUTS FOR EMERGENCY AND FAULT INDICATION	3	3	3

MICROPHONE STATIONS						
						
	ITEM CODE	<b>49BME216</b>	<b>49BME001</b>	<b>49BME012</b>	<b>49PMS006</b>	<b>49PMS012</b>
MAIN FEATURES	COMPATIBLE STATIONS ON THE SAME LINE	49BME216	49BME001, 49BME012	49BME001, 49BME012		
	STATIONS THAT CAN BE CONNECTED IN CASCADE (EVAC RACK)		7	7		
	MICROPHONE TYPE				Electret	Electret
	STATIONS THAT CAN BE CONNECTED IN CASCADE (with 49CC000X panels)	2	4	4		
	NO. OF ZONES THAT CAN BE SELECTED	216		12	6	12
	NO. OF PRIORITY LEVELS THAT CAN BE MANAGED (up to)				7	7
	CERTIFICATION STANDARD	EN54-16	EN54-16	EN54-16		
HARDWARE SPECIFICATIONS	DIMENSIONS (L x H x D - mm)	230 x 80 x 200	140 x 80 x 200	230 x 80 x 200	116x60x200	116x60x200
	WEIGHT (g)	1600	770	1550	580	600
	COMPATIBLE MICROPHONES	49MST002, 49MPA003	49MST002, 49MPA003	49MST002, 49MPA003		
ELECTRICAL SPECIFICATIONS	POWER SUPPLY VOLTAGE	24 VDC	24 VDC	24 VDC	18-30 VDC	18-30 VDC
	FREQUENCY RESPONSE (Hz)	20 - 20000	130 - 19000	130 - 19000	100 - 14000	100 - 14000
	MAX. CURRENT CONSUMED (mA)	165	60	130	16	22
	AUDIO OUTPUT LIVELLO (Vmax)				2.2	2.2
	TYPE OF CABLE FOR CONNECTION	CAT. 5e SF/UTP	CAT. 5e SF/UTP	CAT. 5e SF/UTP	CAT. 5e SF/UTP	CAT. 5e SF/UTP
	MAXIMUM STATION DISTANCE (m)	1000	1000	1000		
	TYPICAL OUTPUT LEVEL (mV)	300	300	300		
	DISTORTION	<1%	<1%	<1%		
LOW CUT FILTER		- 3 db /380 Hz	- 3 db /380 Hz			







# THE RANGE OF EVAC ACCESSORIES

## EVACUATION SPEAKERS

					
	ITEM CODE	<b>49DIR106</b>	<b>49DPQ110</b>	<b>49PLA106</b>	
MAIN FEATURES	CERTIFICATION STANDARD	EN54-24	EN54-24	EN54-24	
	DIMENSIONS	255 x 195 x 88 mm (HxLxD)	170 (ø) x 75 (H)	180 (ø) x 93 (H)	
HARDWARE SPECIFICATIONS	IP PROTECTION RATING	IP21	IP21	IP21	
	COLOUR	White	White RAL9010	White RAL9016	
	WEIGHT (g)	1400	1230	780	
	APPLICATION TYPE	A	A	A	
	FLUSH MOUNTING	Yes		Yes	
	FIXING TYPE	Wall/Ceiling	Wall/Ceiling	Suspended ceiling	
	MOUNTING HOLE	230 x 170 mm		dia. =160 mm	
	OPERATING TEMPERATURE (°C)	-10 - 55	-10 - 55	-10 - 55	
	CABLE CROSS-SECTION (mm <sup>2</sup> )	0.2 - 4	0.2 - 4	0.2 - 4	
	ELECTRICAL SPECIFICATIONS	RATED POWER	6 / 3 / 1.5 W	10 / 6 / 3 / 1.5 W	6 / 3 / 1.5 W
IMPEDANCE (100 V)		1667/3333/6667 Ohm	1000/1667/3333/6667 Ohm	1667/3333/6667 Ohm	
HORIZONTAL DISPERSION ANGLE (*) 500 HZ		180	180	180	
HORIZONTAL DISPERSION ANGLE (*) 1 kHz		180	180	180	
HORIZONTAL DISPERSION ANGLE (*) 2 kHz		120	105	150	
HORIZONTAL DISPERSION ANGLE (*) 4 kHz		50	50	75	
VERTICAL DISPERSION ANGLE (*) 500 HZ		180	180	180	
VERTICAL DISPERSION ANGLE (*) 1 kHz		170	180	180	
VERTICAL DISPERSION ANGLE (*) 2 kHz		130	105	150	
VERTICAL DISPERSION ANGLE (*) 4 kHz		60	50	75	
SOUND PRESSURE LEVEL (SPL) IEC268-5, 1W/1M, (dB)		99.1	102.2	97	
SOUND PRESSURE LEVEL (SPL) IEC268-5, 1W/4M (dB)		87.1	90.2	85	
SOUND PRESSURE LEVEL (SPL) IEC268-5, P <sub>MAX</sub> /4M, (dB)		94.8	100.2	92.7	
SENSITIVITY EN54-24, 1W/4M (dB)		80	81	78	
FREQUENCY RANGE (-10 dB) IEC268-5 (Hz)		93 - 23500	290 - 23400	80 - 20000	
FREQUENCY RESPONSE (Hz)	72 - 23500	230 - 24000	64 - 21500		

















					
	<b>49PLA110</b>	<b>49PRB105</b>	<b>49PRM120</b>	<b>49TRM115</b>	<b>49TRM130</b>
	EN54-24	EN54-24	EN54-24	EN54-24	EN54-24
	220 (ø) x 104 (H) mm	146 (ø) x 202 (L) mm	137.5 (ø) x 202 (L) mm	209 (ø) x 273 (L) mm	235 (ø) x 303 (L) mm
	IP21	IP56	IP66	IP66	IP66
	White RAL9016	White RAL9016	White	RAL7035	RAL7035
	1000	1820	1440	2008	2270
	A	B	B	B	B
	Yes				
	Suspended ceiling dia. =195 mm	Mounting backplate	Mounting backplate	Mounting backplate	Mounting backplate
	-10 - 55	-25 - 70	-25 - 70	-25 - 70	-25 - 70
	0.2 - 4	0.2 - 4	0.2 - 4	0.2 - 4	0.2 - 4
	10 / 5 / 2.5 W	10 / 5 / 2.5 W	20 / 10 / 5 / 2.5 W	15 / 7.5 / 3.75 / 1.9 W	30 / 20 / 10 / 5 W
	1000/2000/4000 Ohm	1000/2000/4000 Ohm	500/1000/2000/4000 Ohm	667/1333/2667/5263 Ohm	333/500/1000/2000 Ohm
		130	360	360	155
		170	230	110	110
		160	110	70	65
		65	58	40	35
	180	130	360	360	155
	175	170	230	110	110
	150	160	110	70	65
	94	65	58	40	35
	97	90.7	99.5	108.5	110.1
	85	78.7	87.5	96.5	98.1
	94.2	88.7	100	108.2	112.8
	81.4	73	75	83	85
	63 - 16000	100 - 20000	120 - 21000	677 - 5400	592 - 6900
	56 - 18000	90 - 25000	150 - 20000	300 - 13800	250 - 15000































# KEY TO ICONS















 EN54-2	product certification
 EN54-3	product certification
 EN54-4	product certification
 EN54-5	product certification
 EN54-7	product certification
 EN54-11	product certification
 EN54-12	product certification
 EN54-13	product certification
 EN54-16	product certification
 EN54-17	product certification
 EN54-18	product certification
 EN54-20	product certification
 EN54-21	product certification
 EN54-23	product certification

 EN54-24	product certification
 EN54-25	product certification
 EN1155	product certification
 EN12094-1	product certification
 EN12101-10	product certification
 EN50200	product certification
 EN50575:2016	product certification
 2 LOOPS	loop
 4 LOOPS	loop
 8 LOOPS	loop
 2 ZONES	zones
 4 ZONES	zones
 6 ZONES	zones
 8 ZONES	zones

 16 ZONES	zones
 64 NETWORK	network
 MODBUS	Modbus protocol
 NETWORK TCP/IP	TCP/IP network
 ESPA 4.4.4	ESPA
 REDUNDANT CPU	REDUNDANT CPU
 ISOLATOR	isolator
 BIM	BIM
 SMOKE	smoke
 TEMPERATURE	temperature
 COMBINED	combined (smoke and heat)
 GAS	gas
 EX	EX (Atex explosion protection)
 ATEX	ATEX

	Frequency (868-869 Mhz)
	1 x battery
	2 x batteries
	modules
	modules
	modules
	modules
	modules
	modules
	modules
	IR
	IR
	IR
	IR

	UV
	UV
	spark
	reflection
	TX-RX
	range
	range
	range
	range
	range
	laser
	turbulence
	number of channels
	number of channels

	class
	class
	class
	number of holes
	number of holes
	sounder
	strobe flash
	32 tones
	electromagnets
	electromagnets
	LCD
	LED
	7-inch
	7-inch touchscreen



# KEY TO ICONS

<p>32 LEDS</p>	32 LEDs	<p>5+5 W EVAC SYSTEMS</p>		<p>110 dB SPL SPEAKERS</p>	
<p>IP 30 PROTECTION RATING</p>	rating	<p>10 W EVAC SYSTEMS</p>		<p>FLUSH MOUNTED SPEAKERS</p>	flush-mounted
<p>IP 33 PROTECTION RATING</p>	rating	<p>20 W EVAC SYSTEMS</p>		<p>WALL MOUNTED SPEAKERS</p>	wall-mounted
<p>IP 40 PROTECTION RATING</p>	rating	<p>1-2 AUDIO IN EVAC SYSTEMS</p>	audio source input	<p>CEILING MOUNTED SPEAKERS</p>	ceiling-mounted
<p>IP 54 PROTECTION RATING</p>	rating	<p>4-20 mA SENSORS</p>	sensors	<p>SUSPENDED SPEAKERS</p>	suspended
<p>IP 55 PROTECTION RATING</p>	rating	<p>RELAYS 1</p>	relays		
<p>IP 65 PROTECTION RATING</p>	rating	<p>RELAYS 3+1</p>	relays		
<p>IP 66 PROTECTION RATING</p>	rating	<p>CEI 20-105</p>			
<p>IP 67 PROTECTION RATING</p>	rating	<p>PH 120</p>			
<p>RS485 EVAC</p>		<p>90 dB SPL SPEAKERS</p>			
<p>500 W EVAC SYSTEMS</p>		<p>97 dB SPL SPEAKERS</p>			
<p>7 INPUTS EVAC SYSTEMS</p>	inputs	<p>99 dB SPL SPEAKERS</p>			
<p>3 OUTPUTS EVAC SYSTEMS</p>	outputs	<p>102 dB SPL SPEAKERS</p>			
<p>6 W EVAC SYSTEMS</p>		<p>108 dB SPL SPEAKERS</p>			

# ANALYTICAL INDEX

059-001	FLUSH SAMPLE POINT KIT AND 2M PIPE	Pag. 48
059-007	CONICAL SAMPLE POINT KIT AND 2M TUBE	Pag. 48
128-014	ROUND SAMPLING POINT LABEL (100 PCS)	Pag. 48
128-015	SMOKE DETECTOR PIPE LABEL (100 PCS)	Pag. 48
128-046	ROUND SAMPLING POINT LABEL (100 PCS)	Pag. 49
144-013	CONICAL SAMPLE POINT HEAD	Pag. 49
221-035	RED 10MM CAPILLARY PIPE (100M)	Pag. 49
221-036	CLEAR 10MM CAPILLARY PIPE (100M)	Pag. 49
222-059	DISCREET END CAP FOR CAPILLARY PIPE (10 PCS)	Pag. 49
30076003	12V DC / 7 AH LEAD BATTERY	Pag. 71
30076004	12V DC / 18 AH LEAD BATTERY	Pag. 71
30076005	12V DC / 26 AH LEAD BATTERY	Pag. 71
30076006	12V DC / 40 AH LEAD ACID BATTERY	Pag. 71
30076012	LEAD BATTERY 12 VDC 65AH	Pag. 71
30076013	LEAD BATTERY 12 VDC 100AH	Pag. 71
41ALM172	ADDITIONAL POWER SUPPLY UNIT FOR 41CPE118	Pag. 13
41BSE000	IP65 BASE FOR ADDRESSED SIRENS	Pag. 18
41CPE104	4 LOOP EXPANSION BOX FOR CONTROL PANEL 41CPE118	Pag. 13 - 100 - 101
41CPE112	1 / 2 LOOP ADDRESSABLE FIRE PANEL	Pag. 11 - 100 - 101
41CPE118	1 / 8 LOOP ADDRESSABLE FIRE PANEL	Pag. 13 - 100 - 101
41CPR100	REPEATER PANEL WITH TOUCH DISPLAY	Pag. 14 - 102
41CRA000	LOCK AND KEYS FOR COMELIT CONTROL PANELS	Pag. 15
41ECB000	REDUNDANT BOARD FOR LOGIFIRE CONTROL PANELS	Pag. 14 - 103
41ECL022	1-LOOP CARD FOR ADDRESSABLE CONTROL PANELS 41CPE112	Pag. 14 - 103
41ECL120	1-LOOP BOARD FOR ADDRESSABLE CONTROL PANEL 41CPE118	Pag. 14 - 103
41ECN000	LAN EXPANSION CARD FOR 41CPE112	Pag. 14
41EVC100	FIRE / EVAC PANEL INTERFACE MODULE	Pag. 15 - 103
41IOM000	ADDRESSABLE MODULE WITH 1 MONITORED OUTPUT	Pag. 19 - 108
41IOM000/240	ADDRESSABLE MODULE, 1 RELAY OUTPUT, 240VAC	Pag. 19 - 109
41IOM000/240XL	ADDRESSABLE MODULE 1 RELAY OUTPUT 240VAC, LARGE BOX	Pag. 19
41IOM000XL	ADDRESSABLE MODULE WITH 1 MONITORED OUTPUT, LARGE BOX	Pag. 19
41IOM004	ADDRESSED MODULE WITH FOUR RELAY OUTPUTS	Pag. 18 - 108
41IOM004XL	ADDRESSABLE MODULE WITH 4 RELAY OUTPUTS, LARGE BOX	Pag. 18
41IOM010	ADDRESSED MINI MODULE WITH 1 INPUT	Pag. 19 - 109
41IOM022	ADDRESSABLE MODULE WITH 2 INPUTS AND 2 OUTPUTS	Pag. 18 - 108
41IOM022XL	ADDRESSABLE MODULE W2 MON IN 2 RELAY OUT, LARGE BOX	Pag. 18
41IOM040	ADDRESSABLE MODULE WITH 4 INPUTS	Pag. 18 - 108
41IOM040XL	ADDRESSABLE MODULE WITH 4 MONITORED INPUTS, LARGE BOX	Pag. 18
41IOM122	ADDRESSABLE MODULE WITH 2 INPUTS/2 OUTPUTS	Pag. 18 - 108
41IOM122XL	ADDRESSABLE MODULE WITH 2 INPUTS AND 2 OUTPUTS, LARGE BOX	Pag. 18
41ISC000	ADDRESSABLE MODULE FOR CONVENTIONAL ZONE	Pag. 19 - 109
41ISC000XL	ADDRESSABLE MODULE FOR CONVENTIONAL ZONE, LARGE BOX	Pag. 19
41KPR101	DESK BASE KIT FOR 41CPR100	Pag. 14
41KPR102	FLUSH-MOUNT INSTALLATION KIT FOR 41CPR100	Pag. 14
41LED032	32-LED MIMIC PANEL MODULE	Pag. 19 - 109
41LTS000 / 41LTS000EN	LOOP TESTER	Pag. 15 - 105
41PAE020	ADDRESSED MANUAL CALL POINT IP67	Pag. 17 - 106
41PAM000	ADDRESSABLE MANUAL CALL POINT	Pag. 16 - 106
41PRN100	THERMAL PRINTER FOR CONTROL PANEL 41CPE118	Pag. 13 - 102
41RBX020	STANDARD ADDRESSABLE BASE	Pag. 16
41RCS100	ADDRESSABLE HEAT DETECTOR	Pag. 16 - 104
41RFU100	ADDRESSABLE OPTICAL SMOKE DETECTOR	Pag. 16 - 104
41RML100	ADDRESSABLE MULTI-CRITERIA SMOKE/HEAT DETECTOR	Pag. 16 - 104
41SAB100	BASE WITH SOUNDER	Pag. 17 - 107
41SAC000	COVER FOR BASE WITH SOUNDER	Pag. 18

# ANALYTICAL INDEX

41SAI000	ADDRESABLE INDOOR SIREN ON LOOP	Pag. 17 - 107
41SCB100	BASE WITH SIREN AND BEACON	Pag. 17 - 107
41SCI000	ADDRESSABLE INDOOR SIREN ON LOOP	Pag. 17 - 107
41SPG000 / 41SPG000EN	PROGRAMMER FOR ADDRESSABLE DEVICES	Pag. 15 - 105
K41VAD100	BASE COMPOSED OF EN54-23 BEACON AND EN54-3 SOUND BASE	Pag. 17
43CPC002EN	CONVENTIONAL ERACLE CONTROL PANEL, 2- ZONES	Pag. 22 - 110
43CPC004EN	CONVENTIONAL ERACLE CONTROL PANEL, 4 ZONES	Pag. 22 - 110
43CPC008EN	CONVENTIONAL ERACLE CONTROL PANEL, 8 ZONES	Pag. 23 - 110
43CPC016EN	ERACLE CONVENTIONAL CONTROL PANEL WITH 8-16 ZONES	Pag. 23 - 111
43CRE000	SET OF 5 PAIRS OF KEYS FOR ERACLE CONTROL PANEL	Pag. 24
43ECR032	EXPANSION MODULE 8 RELAY OUTPUTS FOR ERACLE 8/16	Pag. 24 - 111
43ECS020	EXPANSION CARD WITH 4 SOUNDER CIRCUITS FOR ERACLE 16	Pag. 24
43ECZ020	EXPANSION CARD WITH 4 ZONES FOR ERACLE 16	Pag. 24
43EOL000	SET OF 5 EOL FOR CONVENTIONAL ZONE	Pag. 24
43LEC000	EVENT LOG FOR ERACLE 16	Pag. 24
43PAE020	CONVENTIONAL MANUAL CALL POINT IP67	Pag. 27 - 113
43PAK000	SPARE KEY FOR FIRE BUTTONS	Pag. 17 - 27
43PAM000	CONVENTIONAL MANUAL CALL POINT	Pag. 27 - 113
43PAT000	PLASTIC COVER FOR MANUAL CALL POINT, SET OF 5	Pag. 17 - 27
43RBA002	SPACER FOR CONVENTIONAL DETECTORS	Pag. 16 - 26 - 39
43RBR003	SPACER FOR FIRE SOUNDERS, RED	Pag. 39
43RBX000	STANDARD CONVENTIONAL BASE	Pag. 25
43RBX001	CONVENTIONAL BASE WITH DIODE	Pag. 26
43RBX003	BASE WITH RELAY FOR CONVENTIONAL SENSORS	Pag. 26
43RBX004	CONVENTIONAL BASE WITH DIODE - 45MA HIGH CURRENT	Pag. 26
43RBX005	TALL BASE FOR CONVENTIONAL DETECTORS	Pag. 26
43RCS100	CONVENTIONAL HEAT DETECTOR, THRESHOLD 58°	Pag. 25 - 112
43RCS101	CONVENTIONAL HEAT DETECTOR, THRESHOLD 60°	Pag. 25 - 112
43RCS102	CONVENTIONAL HEAT DETECTOR, THRESHOLD 75°	Pag. 25 - 112
43RFU100	CONVENTIONAL OPTICAL SMOKE DETECTOR	Pag. 25 - 112
43RML100	CONVENTIONAL MULTI-CRITERIA DETECTOR	Pag. 25 - 112
45FPT000	WIRELESS LED REPEATER	Pag. 30 - 120
45MOD000	BOARD FOR WIRELESS SOUNDERS	Pag. 31
45PAK001	SPARE KEY FOR WIRELESS BUTTON SGC2P00	Pag. 31
45RPT000	WIRELESS SIGNAL REPEATER	Pag. 30 - 118
45SAC000	COVER FOR WIRELESS SOUNDER BASE	Pag. 31
45SAI020	WIRELESS SOUNDER	Pag. 31 - 121
45SCI000	WIRELESS SIREN WITH BEACON	Pag. 31 - 121
45TRS000	WIRELESS SIGNAL TRANSLATOR	Pag. 30 - 118
46EST003	EXTINGUISHANT CONTROL PANEL	Pag. 34 - 122
46LEP000	EVENT LOG FOR EXTINGUISHANT CONTROL PANEL	Pag. 35
46PMA100	YELLOW BUTTON FOR EXTINGUISHING ACTIVATION	Pag. 35 - 123
46PMS120	BLUE BUTTON FOR EXTINGUISHING SYS. DEACTIVATION	Pag. 35 - 123
47ADB012	POWER SUPPLY UNIT FOR 12V LITHIUM BATTERY	Pag. 58 - 133
47ADG206	DIN RAIL POWER SUPPLY UNIT FOR CONTROL PANEL 47CDG206	Pag. 58 - 133
47BDL012	LITHIUM BATTERY ON DIN RAIL	Pag. 58 - 133
47CDG206	GAS CONTROL PANEL ON DIN RAIL 2 - 6 SENSORS	Pag. 58 - 132
47CMZ001	SINGLE-ZONE WALL-MOUNTED GAS CONTROL PANEL	Pag. 59 - 134
47CPG408	WALL-MOUNTED GAS CONTROL PANEL 4 - 8 SENSORS	Pag. 57 - 130
47CPG424	WALL-MOUNTED GAS CONTROL PANEL 4 - 24 SENSORS	Pag. 56 - 130
47CPZ003	WALL-MOUNTED GAS CONTROL PANEL 3 DETECTORS	Pag. 59 - 134
47EDG020	2 SENSORS EXPANSION FOR 47CDG206	Pag. 58 - 133
47ESP040	4 INPUT EXPANSION FOR GAS CONTROL PANEL 47CPG424	Pag. 57
47ESP080	8 INPUTS EXPANSION FOR GAS CONTROL PANEL 47CPG424	Pag. 57 - 131
47REL040	4 RELAY EXPANSION FOR GAS CONTROL PANELS	Pag. 57

47RFG000	LPG DETECTOR FOR DOMESTIC USE	Pag. 61 - 137
47RFM000	METHANE GAS DETECTOR FOR DOMESTIC USE	Pag. 61 - 137
47RTS282EC-S	AUTONOMOUS INDUSTRIAL GAS DETECTOR CO	Pag. 60 - 137
47RTS282EO	AUTONOMOUS INDUSTRIAL GAS DETECTOR OXYGEN	Pag. 60 - 137
47RTS282KB	AUTONOMOUS INDUSTRIAL GAS DETECTOR PETROL VAPOUR	Pag. 60 - 137
47RTS282KG	AUTONOMOUS INDUSTRIAL GAS DETECTOR LPG	Pag. 60 - 136
47RTS282KI	AUTONOMOUS INDUSTRIAL GAS DETECTOR HYDROGEN	Pag. 60 - 136
47RTS282KM	AUTONOMOUS INDUSTRIAL GAS DETECTOR METHANE	Pag. 60 - 136
47SE192KG	LPG GAS DETECTOR	Pag. 59 - 135
47SE192KM	METHANE GAS DETECTOR	Pag. 59 - 135
47SER080	BOARD W/4 RELAY OUTPUTS FOR 47ESP080 (MAX. 2)	Pag. 57
47TS255CB	INDUSTRIAL DUAL GAS DETECTOR 4-20MA	Pag. 60 - 136
47ZSEC/IP	AUTONOMOUS INDUSTRIAL GAS CARTRIDGE CO	Pag. 61
47ZSEC1	GAS CARTRIDGE FOR CO DETECTOR 47TS255CB	Pag. 61
47ZSE0/IP	AUTONOMOUS INDUSTRIAL GAS CARTRIDGE OXYGEN	Pag. 61
47ZSK01/IP	AUTONOMOUS INDUSTRIAL GAS CARTRIDGE METHANE + LPG	Pag. 61
47ZSK02/IP	AUTONOMOUS INDUSTRIAL GAS CARTRIDGE HYDROGEN	Pag. 61
47ZSK04	CARTRIDGE FOR PETROL FUMES DETECTOR 47TS255CB	Pag. 61
47ZSKB/IP	AUTONOMOUS INDUSTRIAL GAS CARTRIDGE FOR PETROL VAPOURS	Pag. 61
48BAZ000	ZENER BARRIER FOR ATEX DETECTORS	Pag. 64 - 138
48BAZ001	ZENER BARRIER FOR ATEX SOUNDER	Pag. 64 - 138
48BFA003	FLUSH MOUNT BOX FOR 48BFC000	Pag. 52
48BFA004	SPARE REFLECTOR FOR 48BFC002	Pag. 52
48BFA006	SPARE REFLECTOR FOR 48BFC003	Pag. 52
48BFC000	LINEAR SMOKE DETECTOR 3 30 M	Pag. 52 - 128
48BFC002	LINEAR SMOKE DETECTOR 5-50 M	Pag. 52 - 128
48BFC003	LINEAR SMOKE DETECTOR 50-100 M	Pag. 52 - 128
48BIA100	FLUSH-MOUNT FRAME FOR LOGIFIRE CONTROL PANELS	Pag. 15
48CAC001	DUCT DETECTOR	Pag. 68
48CCB100	LOGIFIRE BOX FOR ADDITIONAL BATTERIES	Pag. 15
48CLU003	AUDIO-VISUAL WARNING SIGN EN54 3/23	Pag. 38 - 114
48CLU006	INTERCHANGEABLE "FIRE ALARM" TEXT FOR VISUAL/AUDIBLE SIGN 48CLU003	Pag. 38
48CLU007	INTERCHANGEABLE "EVACUATE IMMEDIATELY" TEXT FOR OPTICAL/AUDIBLE SIGN 48CLU003	Pag. 38
48CLU008	INTERCHANGEABLE "DO NOT ENTER GAS RELEASED" TEXT FOR OPTICAL/AUDIBLE SIGN 48CLU003	Pag. 38
48CME000	6" OUTDOOR BELL 24 V DC 12 mA EN54	Pag. 41 - 117
48CMI000	6" INDOOR BELL 24 V DC 12 mA EN54	Pag. 41 - 117
48CTR068	LINEAR HEAT DETECTION CABLE, NON RESETTABLE, 68°C	Pag. 70 - 140
48CTR105	LINEAR HEAT DETECTION CABLE, NON RESETTABLE, 105°C	Pag. 70 - 140
48CTS020	MAGNETIC CHANGEVER CONTACT WITH TERMINAL	Pag. 35
48CVE115	EVAC CABLE EN50575 PH120 2x1.5 100M	Pag. 70
48CVE125	EVAC CABLE EN50575 PH120 2x2.5 100M	Pag. 70
48CVI115	FIRE CABLE EN50575 PH120 2x1.5 100M	Pag. 70
48CVI125	FIRE CABLE EN50575 PH120 2x2.5 100M	Pag. 70
48CVI515	FIRE CABLE EN50575 PH120 2x1.5 500M	Pag. 70
48CVI525	FIRE CABLE EN50575 PH120 2x2.5 500M	Pag. 70
48FMA01	ALUMINIUM COVER FOR 48FME051	Pag. 69
48FMA02	ALUMINIUM COVER FOR 48FME101	Pag. 69
48FMA03	FLOOR-STANDING BACKPLATE FOR 48FME051 AND 48FME101	Pag. 69
48FME051	50 KG MAGNETIC DOOR HOLDER	Pag. 68 - 141
48FME052	MAGNETIC DOOR HOLDER 50 KG WITH 15CM BACKPLATE	Pag. 68 - 141
48FME053	MAGNETIC DOOR HOLDER 50 KG WITH 30CM BACKPLATE	Pag. 69 - 141
48FME101	100 KG MAGNETIC DOOR HOLDER	Pag. 69 - 141
48FPT100	REMOTE LED INDICATOR	Pag. 16 - 25 - 103 - 113
48LME000	CEILING-MOUNTED BEACON, IP65	Pag. 40 - 117
48LME020	WALL-MOUNTED BEACON, IP65	Pag. 40 - 117

# ANALYTICAL INDEX

48LMI000	CEILING-MOUNTED BEACON, IP21	Pag. 40 - 117
48LMI020	WALL-MOUNTED BEACON, IP21	Pag. 40 - 117
48PAX000	ATEX MANUAL CALL POINT	Pag. 64 - 139
48RBX000	MOUNTING BASE FOR ATEX DETECTORS	Pag. 64
48RCX000	ATEX HEAT-RATE OF RISE DETECTOR	Pag. 64 - 138
48RFX000	ATEX WIRELESS OPTICAL SMOKE DETECTOR	Pag. 64 - 138
48SAE000	ELECTRONIC SOUNDER - IP66 EN54	Pag. 38 - 114
48SAE001	BACKPLATE FOR 48SAE000 SOUNDER IP66 MOUNTING	Pag. 38
48SAE300	CONVENTIONAL OUTDOOR SOUNDER, EN54-3	Pag. 38 - 114
48SAI020	INDOOR 32-TONE SOUNDER	Pag. 38 - 115
48SAI050	INDOOR SIREN WITH STROBE	Pag. 38 - 115
48SAX000	ATEX SOUNDER	Pag. 64 - 139
48SCE000	CEILING-MOUNTED SOUNDER BEACON, IP65	Pag. 40 - 116
48SCE020	WALL-MOUNTED SOUNDER BEACON, IP65	Pag. 40 - 116
48SCIO00	CEILING-MOUNTED SOUNDER BEACON, IP21	Pag. 40 - 116
48SCIO20	WALL-MOUNTED SOUNDER BEACON, IP21	Pag. 40 - 116
48SCIO40	SIREN WITH RED BEACON	Pag. 39 - 115
48SCIO60	SIREN WITH WHITE BEACON	Pag. 39 - 115
48SDT001	AEROSOL FOR SMOKE DETECTOR TESTING	Pag. 70
49BME001	REMOTE EMERGENCY CALL POINT	Pag. 76 - 143
49BME012	12-ZONE REMOTE EMERGENCY CALL STATION	Pag. 76 - 143
49BME216	EMERGENCY REMOTE TOUCH-SENSITIVE STATION	Pag. 76 - 143
49CC0002	COMPACT 2-ZONE EVAC CONTROL PANEL	Pag. 74 - 142
49CC0004	COMPACT 4-ZONE EVAC CONTROL PANEL	Pag. 75 - 142
49CC0006	COMPACT 6-ZONE EVAC CONTROL PANEL	Pag. 75 - 142
49CVF001	WALL CABINET FOR MICROPHONE STATIONS	Pag. 77
49DIR106	RECTANGULAR FLUSH-MOUNT SPEAKER EN54-24	Pag. 78 - 144
49DPQ110	WALL-MOUNT ROUND SPEAKER, EN54-24	Pag. 78 - 144
49MPA003	HANDHELD MICROPHONE FOR REMOTE POINT	Pag. 77
49MSC006	KIT OF 6 CERAMIC TERMINALS FOR SPEAKERS	Pag. 77
49MST002	STALK-MOUNTED MICROPHONE FOR REMOTE POINT	Pag. 77
49PLA106	6W CAVITY CEILING LIGHT EN54-24	Pag. 78 - 144
49PLA110	10W CAVITY CEILING LIGHT EN54-24	Pag. 78 - 144
49PMS006	MICROPHONE POINT WITH 6-ZONE MICROPHONE	Pag. 76 - 143
49PMS012	MICROPHONE STATION WITH 12-ZONE MICROPHONE	Pag. 77 - 143
49PRB105	5+5W BIDIRECTIONAL SPOTLIGHT EN54-24	Pag. 78
49PRM120	20W MONODIRECTIONAL SPOTLIGHT EN54-24	Pag. 79 - 144
49TRM115	HORN SPEAKER, 15W EN54-24 IP66	Pag. 79 - 144
49TRM130	HORN SPEAKER, 30W EN54-24 IP66	Pag. 79 - 144
COLL250	ADHESIVE FOR PIPES AND SOCKETS 250ML	Pag. 48
CT400EN	TELEPHONE DIALLER PSTN GSM 3G EN54-21	Pag. 68 - 141
CT440EN	TELEPHONE DIALLER PSTN GSM 3G IP EN54-21	Pag. 68 - 141
IFT-P	ASPIRATING SMOKE DETECTOR, 1 ZONE	Pag. 44 - 124
ILS-1	ASPIRATING DETECTOR, 1 ZONE	Pag. 44 - 124
ILS-2	ASPIRATING DETECTOR, 1 ZONE	Pag. 44 - 124
ISP-001	REPLACEMENT FILTER ELEMENT, ILS1/2 + IFT-P 10 PCS	Pag. 48
ISP-002	REPLACEMENT FILTER ELEMENT, IFT-P STAGE 2, 10 PCS	Pag. 48
L-HT-SG	WIRELESS HEAT DETECTOR	Pag. 30 - 119
L-MC-SG	WIRELESS MULTI-CRITERIA DETECTOR	Pag. 30 - 119
L-OP-SG	WIRELESS OPTICAL SMOKE DETECTOR	Pag. 30 - 119
PIP-001	RED ABS 25 MM PIPE, 20X 3 METRES	Pag. 46
PIP-002	CONNECTION SOCKET FOR 25MM PIPE (10 PCS)	Pag. 46
PIP-003	SOCKET UNION FOR 25MM PIPE (10 PCS)	Pag. 46
PIP-005	90 ELBOW FOR 25MM PIPE (10 PCS)	Pag. 46
PIP-006	45 ELBOW FOR 25MM PIPE (10 PCS)	Pag. 46



PIP-007	END CAP FOR 25MM PIPE (10 PCS)	Pag. 46
PIP-008	EQUAL TEE FOR 25MM PIPE (10 PCS)	Pag. 47
PIP-009	CLIP FOR 25MM PIPE (20 PCS)	Pag. 47
PIP-014	PIPE CUTTERS	Pag. 47
PIP-015	FLUSH SAMPLE POINT HEAD FOR CAPILLARY PIPE	Pag. 47
PIP-016	TEE ADAPTER FOR CAPILLARY PIPE (10 PCS)	Pag. 47
PIP-021	25MM FLEXIBLE CONNECTOR, 100 CM	Pag. 47
PIP-025	WATER FILTER WITH TRANSPARENT PIPE AND VALVE	Pag. 48
PIP-026	25MM FLEXIBLE CONNECTOR, 30 CM	Pag. 48
PIP-027	REMOTE SAMPLING TEST POINT FOR CAPILLARY TUBE	Pag. 48
RK100-B	LINEAR SMOKE/HEAT DETECTOR 120 M TX+RX	Pag. 52 - 126
RK100-BS	LINEAR SMOKE DETECTOR 120 M TX+RX	Pag. 53 - 126
RK100-BS-EX	LINEAR SMOKE DETECTOR 120 M TX+RX, ATEX	Pag. 53 - 127
RK200-B	LINEAR SMOKE/HEAT DETECTOR 200 M TX+RX	Pag. 53 - 127
RK200-BS	LINEAR SMOKE DETECTOR 200 M TX+RX	Pag. 53 - 127
SGCP200	WIRELESS MANUAL ALARM BUTTON	Pag. 30 - 120
SGMCB200	MODULE WITH 1 OUTPUT VIA RADIO	Pag. 31
SGMI200	MODULE WITH 1 INPUT VIA RADIO	Pag. 31
SGRBS100/L	WIRELESS SOUNDER BASE	Pag. 31 - 121
VSP-850-R	25MM IN-LINE EXTERNAL FILTER - RED	Pag. 48
VSP-855-4	REPLACEMENT FOR FILTER VSP-850-R - 4 PIECES	Pag. 48
ZSP100-2.5A-18	2.5A ADDITIONAL POWER SUPPLY UNIT	Pag. 68 - 140
ZSP100-5.5A-18	5.5A ADDITIONAL POWER SUPPLY UNIT	Pag. 68 - 140



A series of 20 horizontal dotted lines spanning the width of the page, providing a guide for handwriting practice.





8 023903 425284 cod. 2631000618



The brands and trade names cited in this publication are the property of their respective owners.  
Product dimensions derived from the images are purely indicative.